

# ARIANA

## szejkényisor

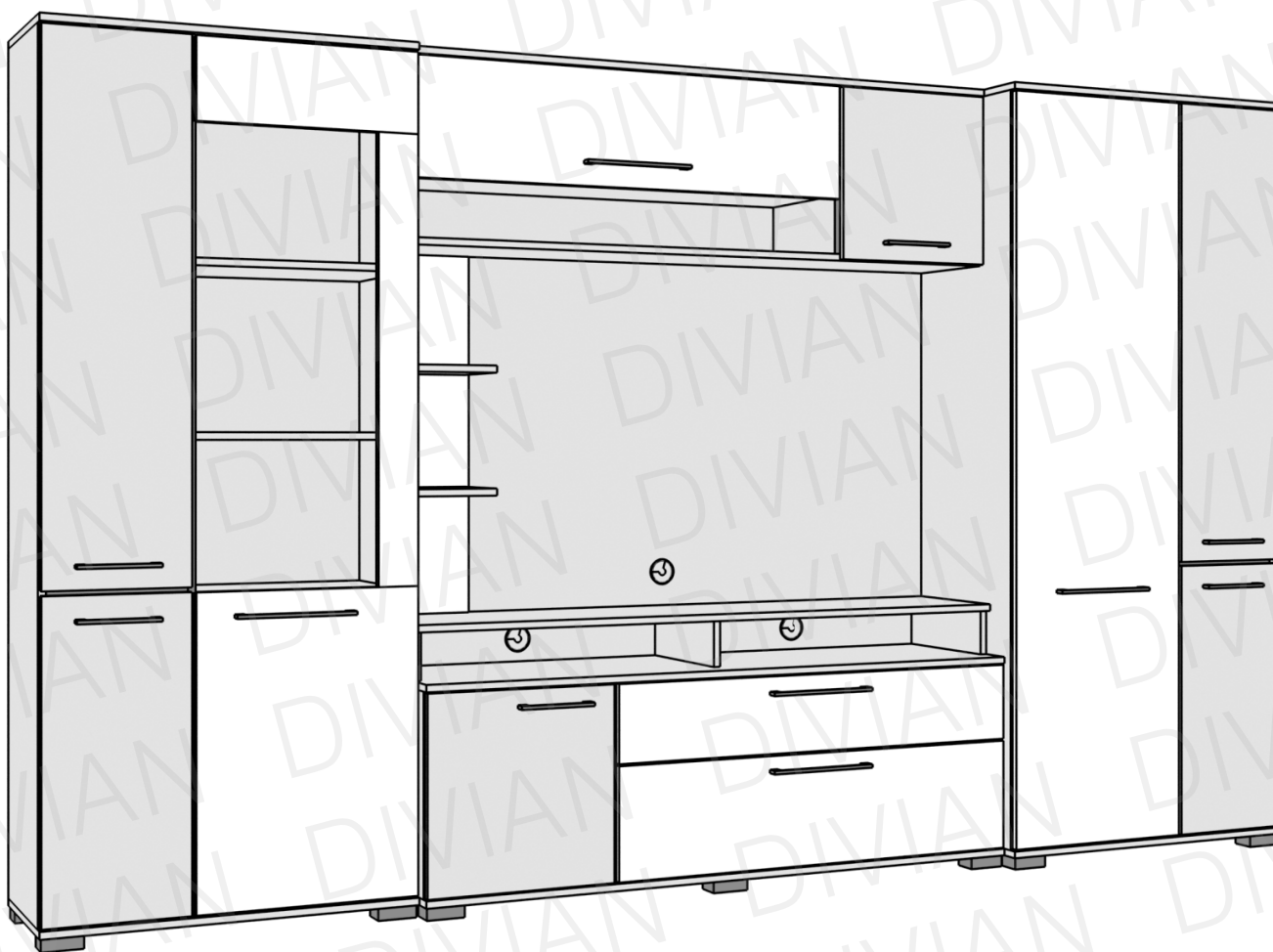

## SZERELÉSI ÚTMUTATÓ

## Szekrény csomag tartalma:



bútorösszehúzó M6x30 8db

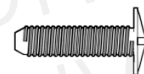

bútorösszehúzó M4x12 8db



polctartó 48db

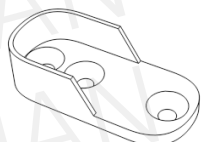

rúdtárcsa 2db



3,5x16 csavar 4db



Konfirmátor csavar 4db

## Szükséges szerszámok:

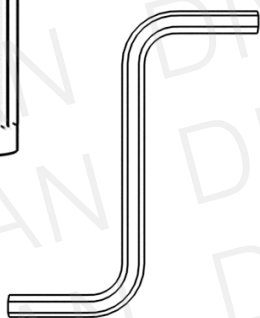

## Ne egyedül végezze az összeállítást!

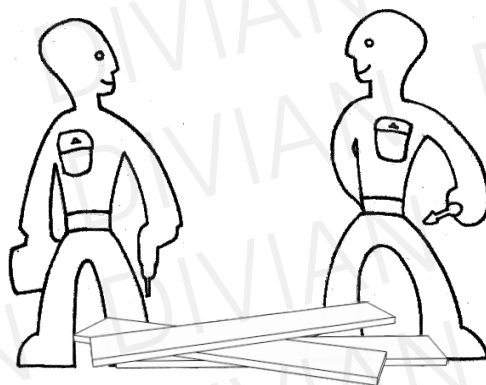

Óvja az elemeket a sérülésektől!

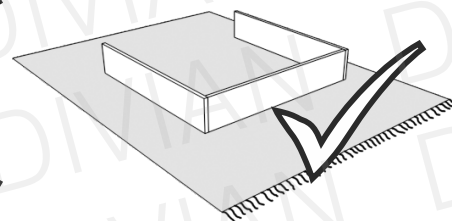
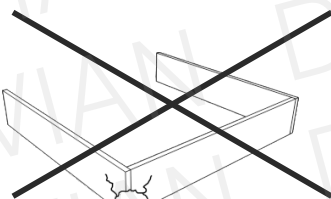

A csomagok több alkatrészt tartalmazhatnak, mint amennyire szüksége van!

# ELEMEK

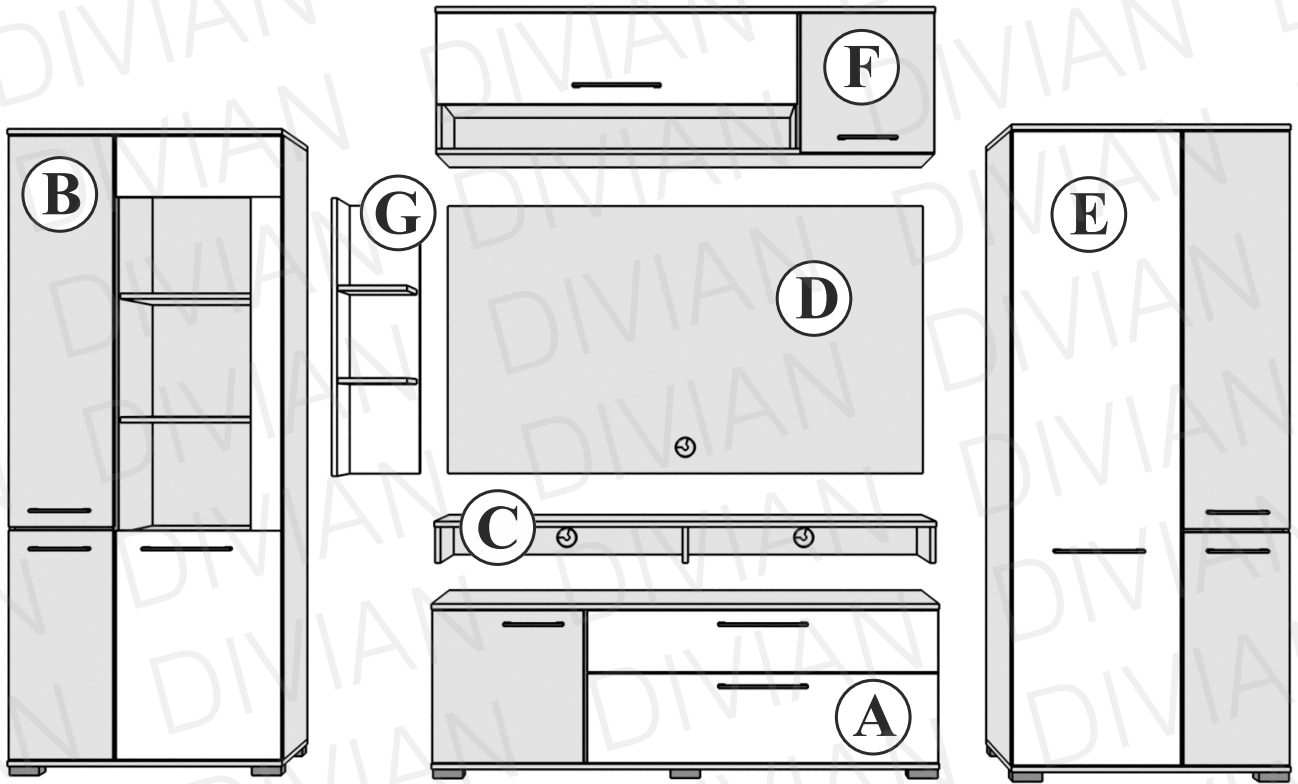

A könnyebb áttekinthetőség érdekében a szerelési útmutatóban az adott elemeket ajtók nélkül ábrázoljuk. Az összeszereléshez Önnek természetesen nem szükséges levennie az ajtókat!

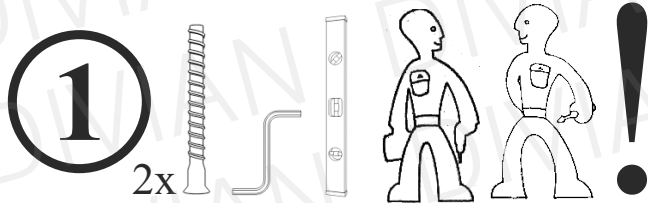

**i** Hátfalak síkban legyenek.

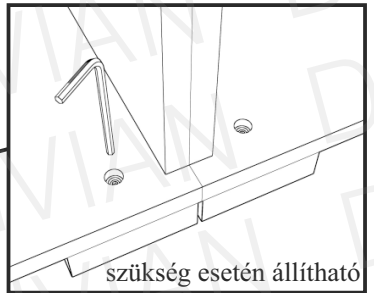
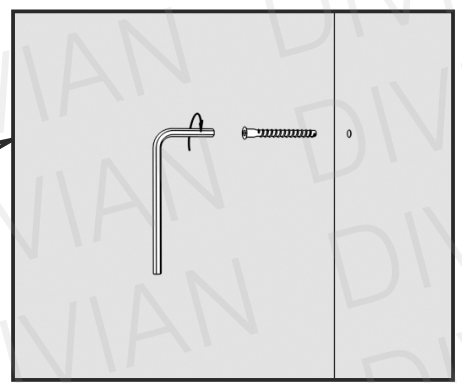
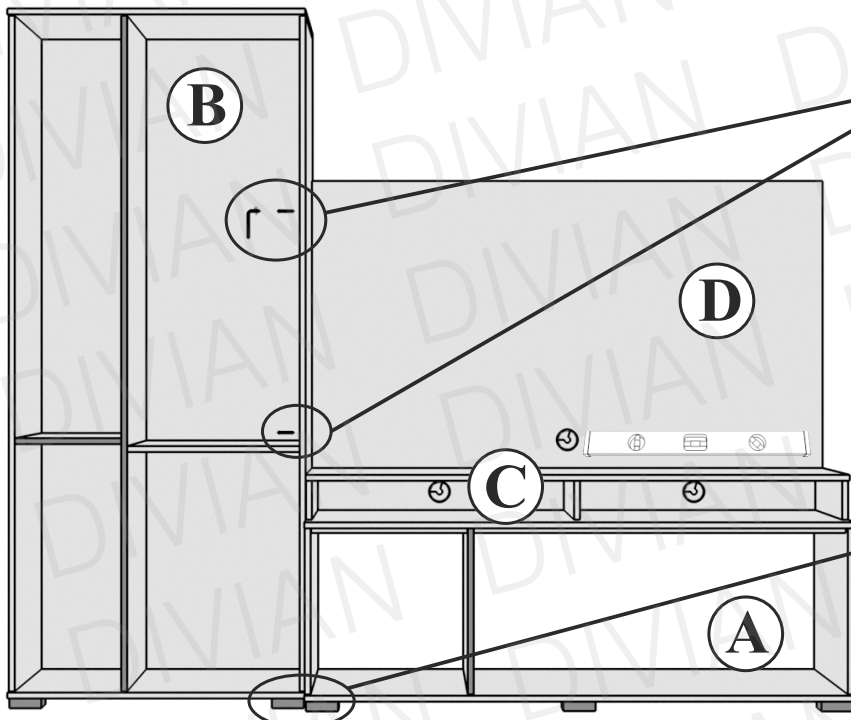

szükség esetén állítható

2

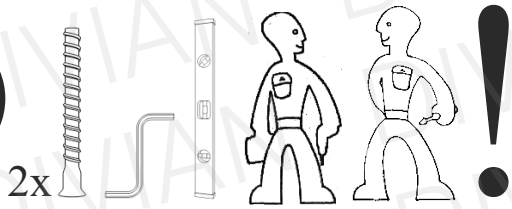

**i** Hátfalak síkban legyenek.

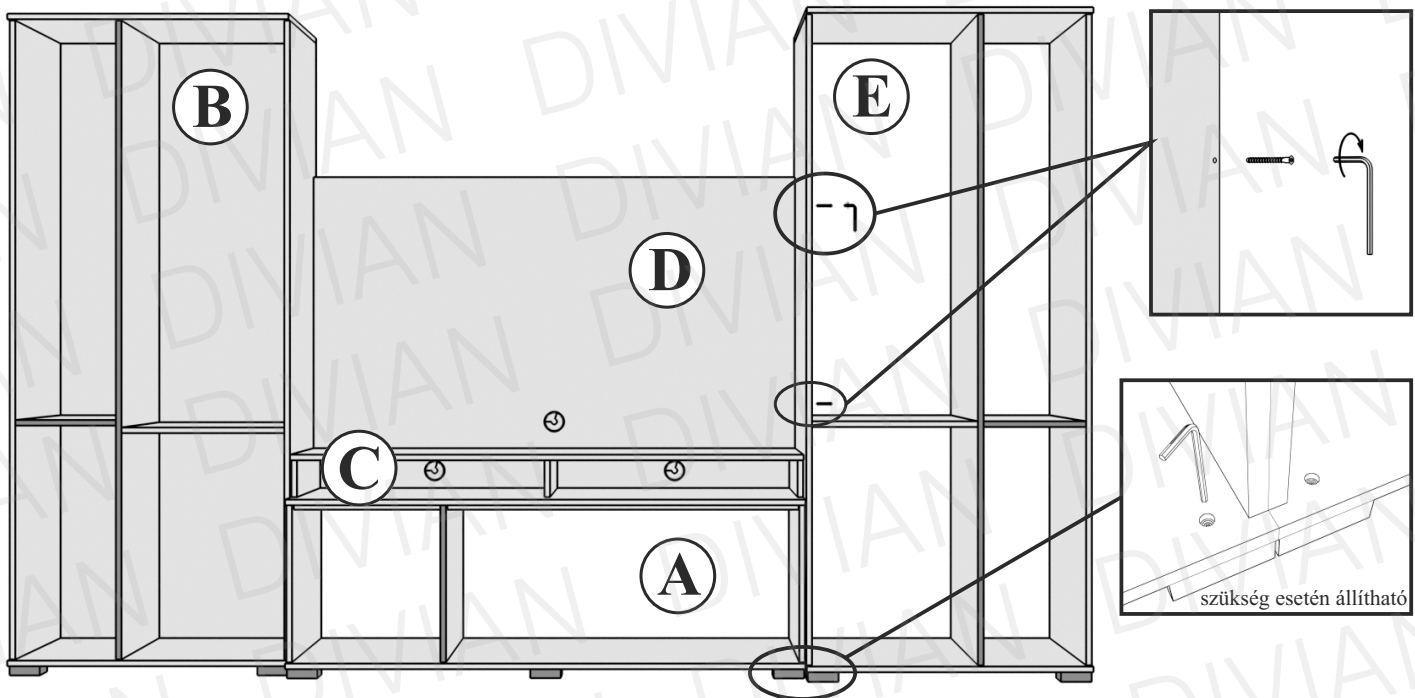

3

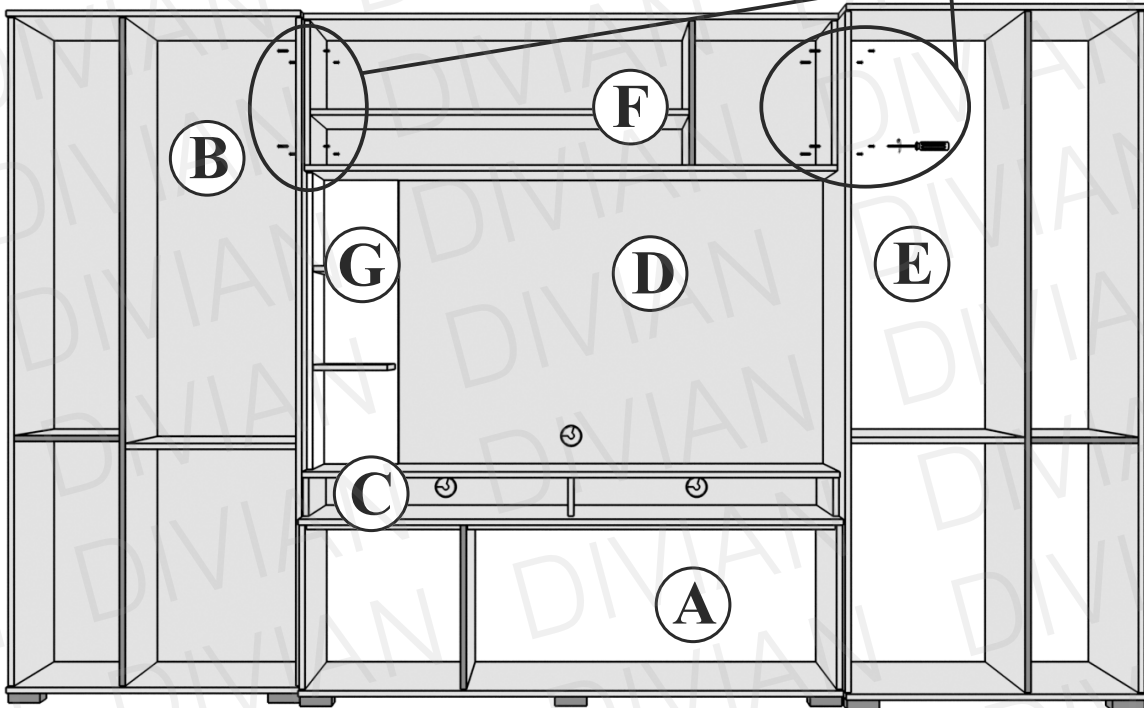
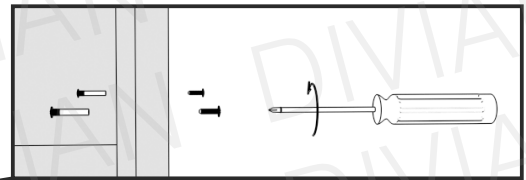

4

2x



4x

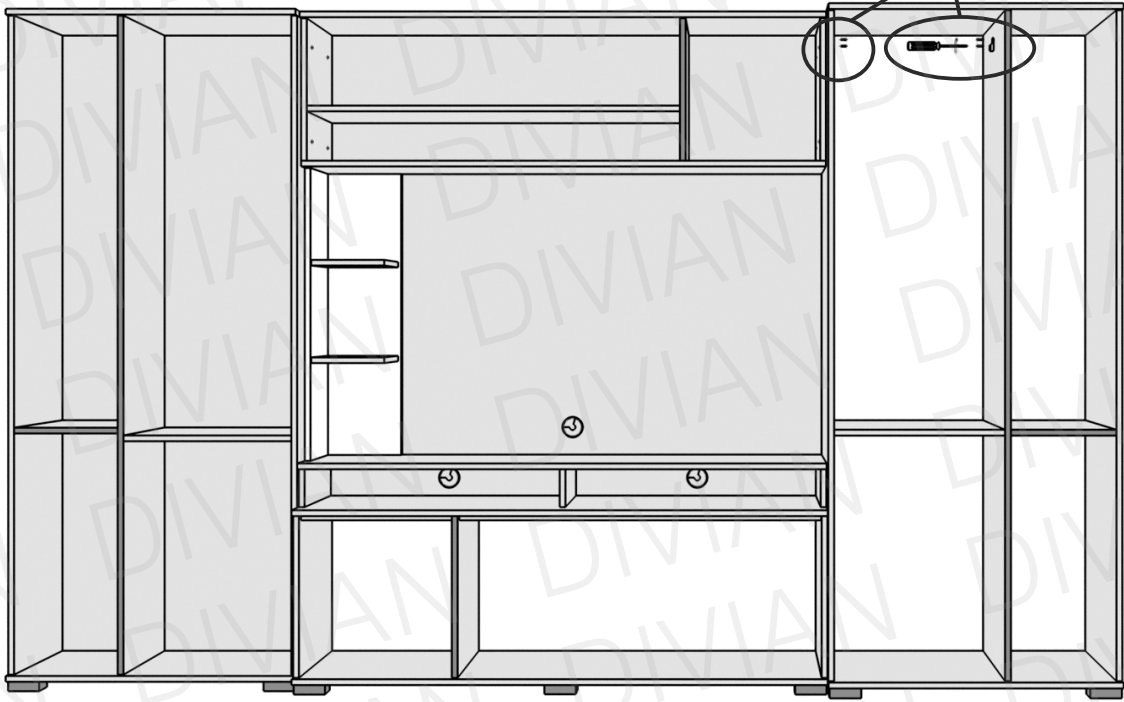
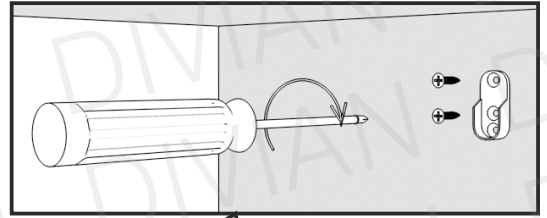

5

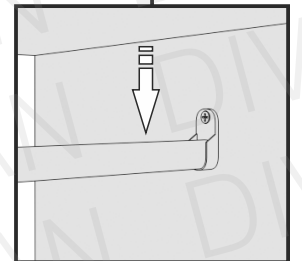
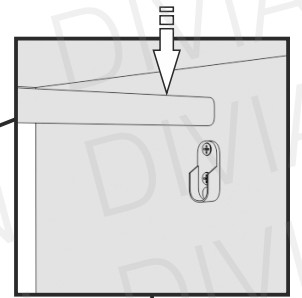
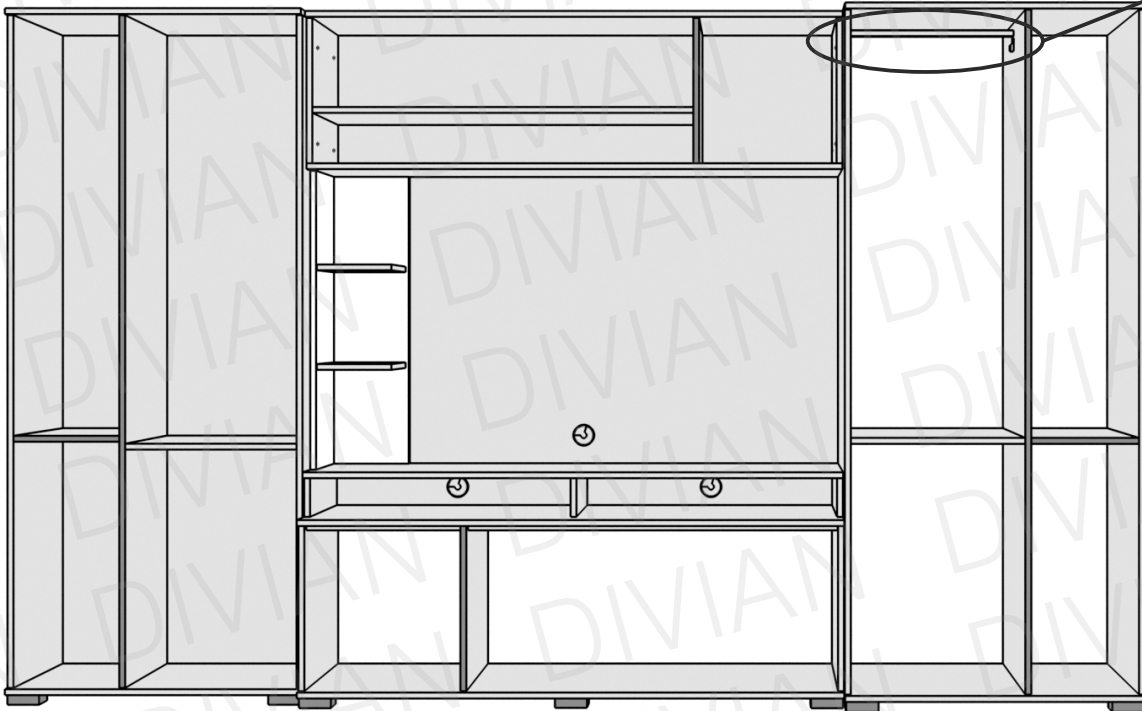

**6**

48x

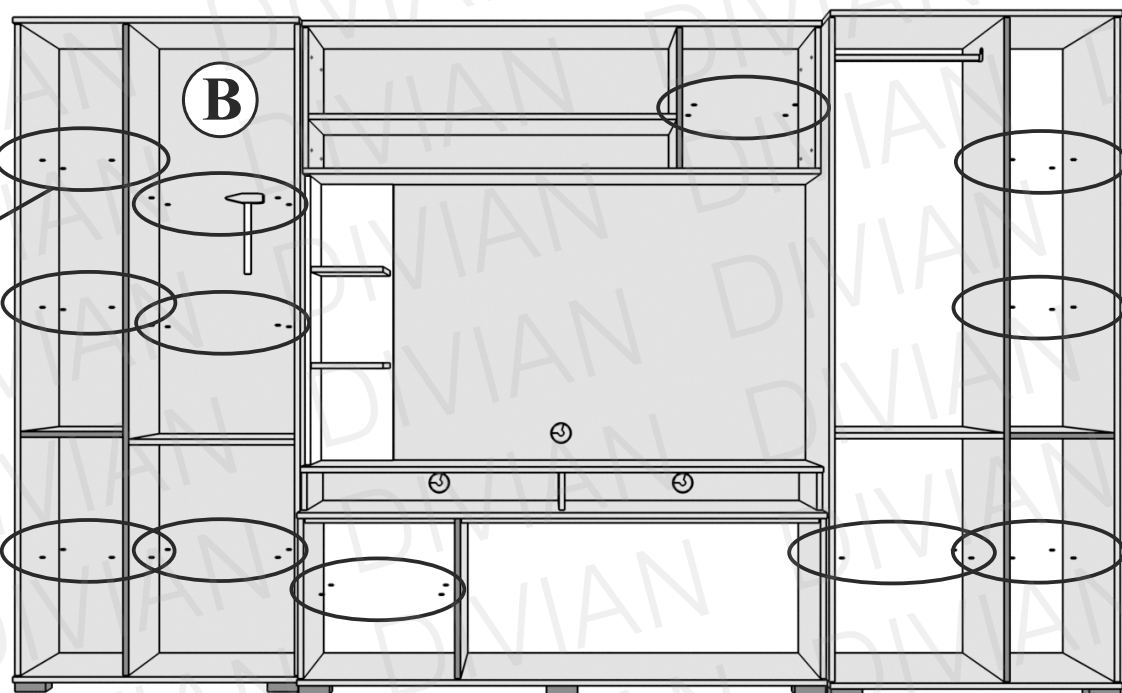
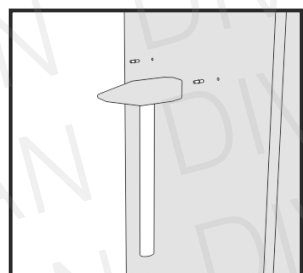
**i**

Amennyiben LED világítást is vásároltak, azt még a polcok behelyezése előtt helyezték be a B elembe. A ledek szereléséhez szükséges alkatrészeket, a LED dobozában találja.

**7**