

HAVANNA

szekréénysor

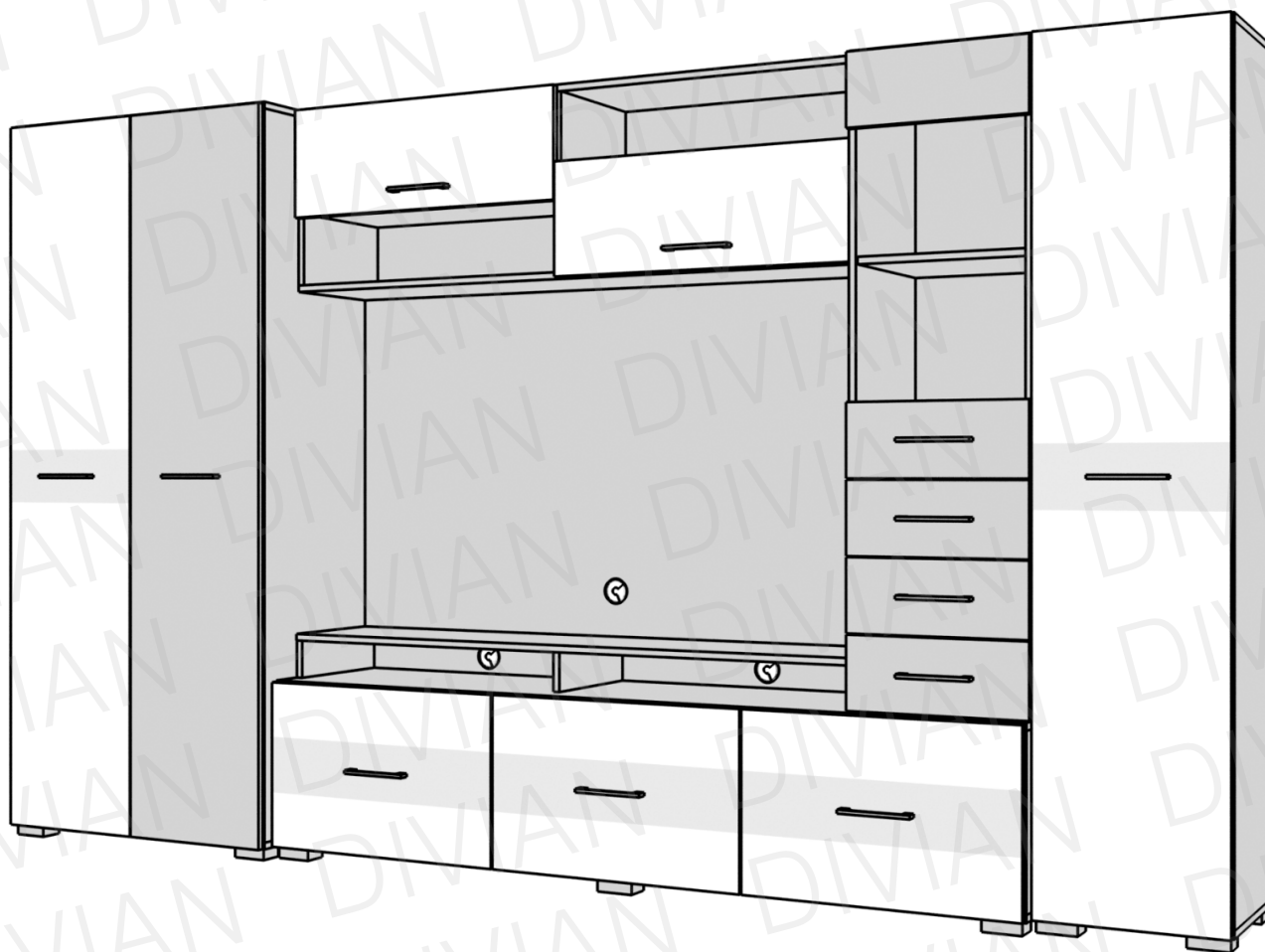

SZERELÉSI ÚTMUTATÓ

Szekrény csomag tartalma:



bútorösszehúzó M6x30 12db



bútorösszehúzó M4x12 12db



polctartó 12db

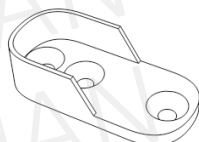

rúdtárcsa 2db



3,5x16 csavar 4db



Konfirmátor csavar 4db

Szükséges szerszámok:

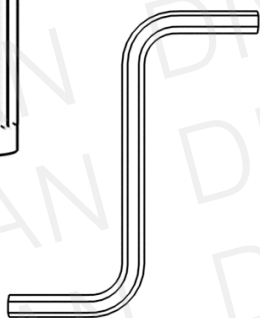

Ne egyedül végezze az összeállítást!

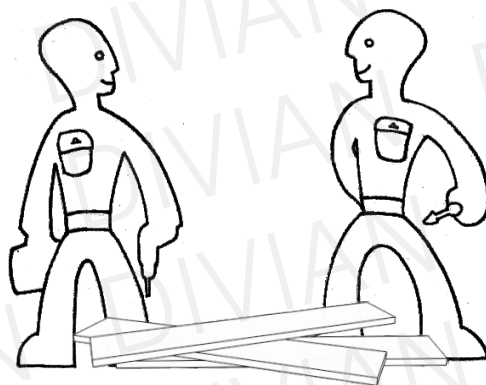

Óvja az elemeket a sérülésektől!

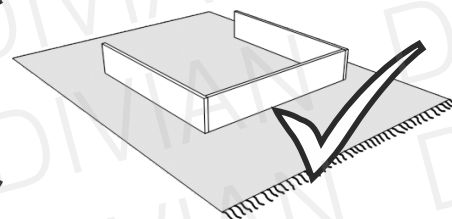
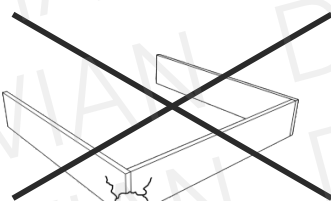

A csomagok több alkatrészt tartalmazhatnak, mint amennyire szüksége van!

ELEMEK

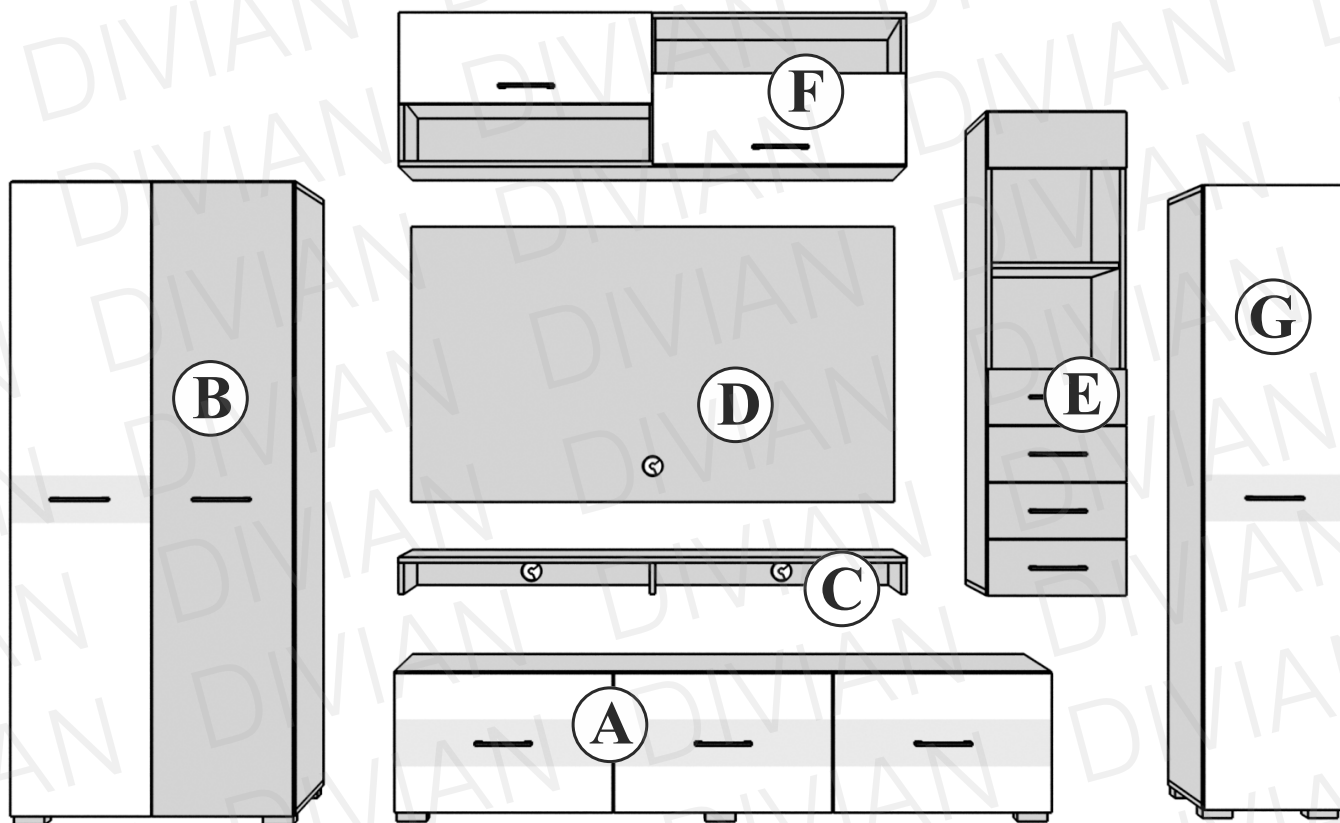

A könnyebb áttekinthetőség érdekében a szerelési útmutatóban az adott elemeket ajtók nélkül ábrázoljuk. Az összeszereléshez Önnek természetesen nem szükséges levennie az ajtókat!

1

i

Az E elemből távolítsák el a középső fiókot, hogy hozzáférjenek a szerelési pontokhoz. Könnyebb szerelés érdekében a felső fiók is eltávolítható.

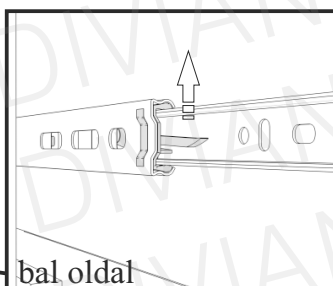
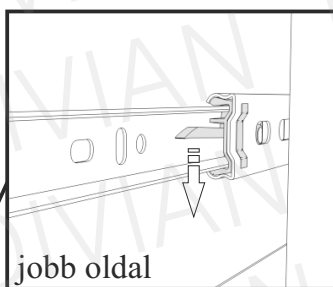

i

Fiók eltávolításához, húzza ki teljesen a fiókot, és bal oldalt nyomja felfele, jobb oldalt nyomja lefele a műanyag kis kart, és húzza tovább a fiókot.

2

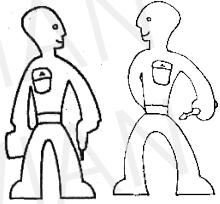

i

Hátfalak síkban legyenek.

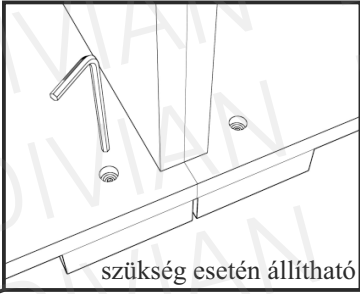
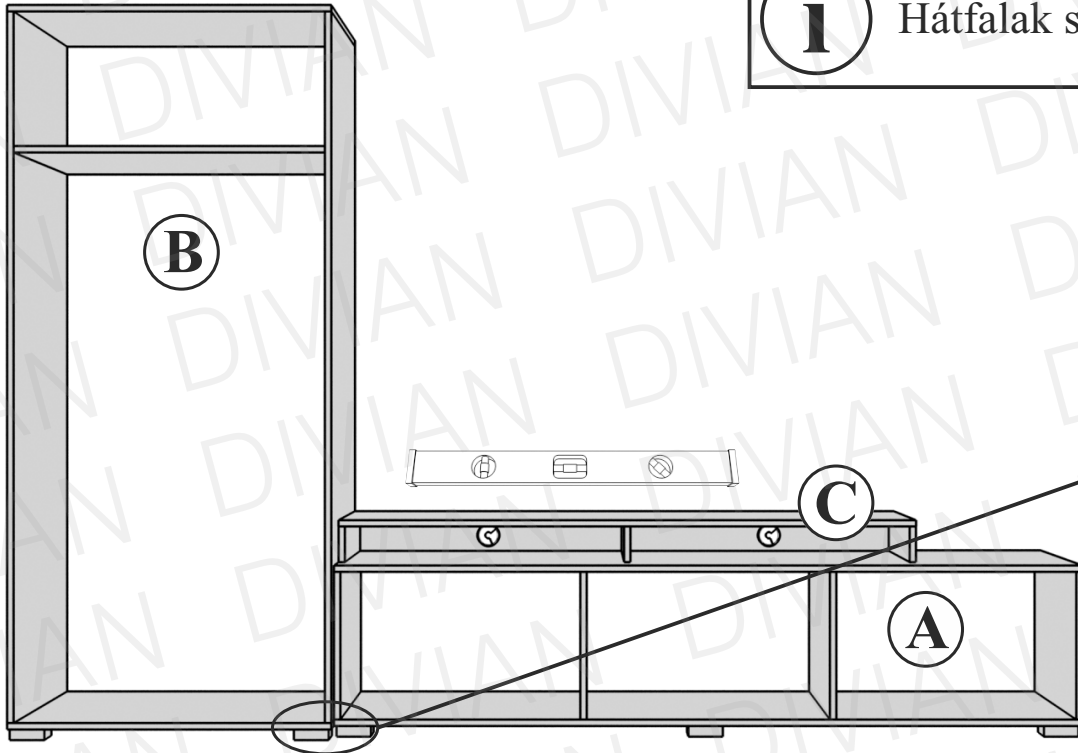

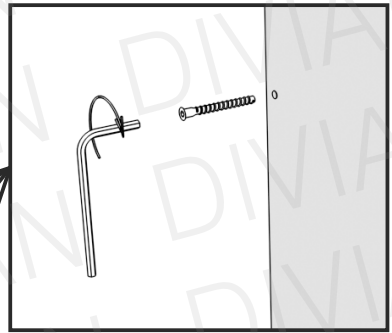
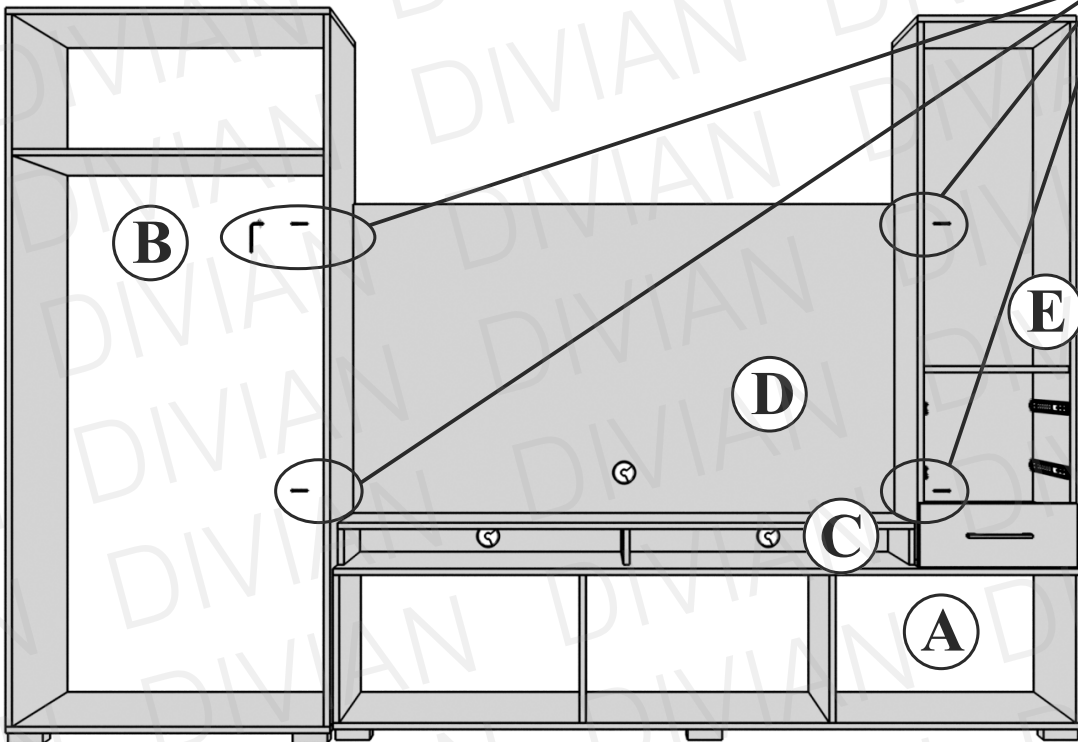
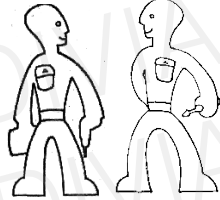

3

4x



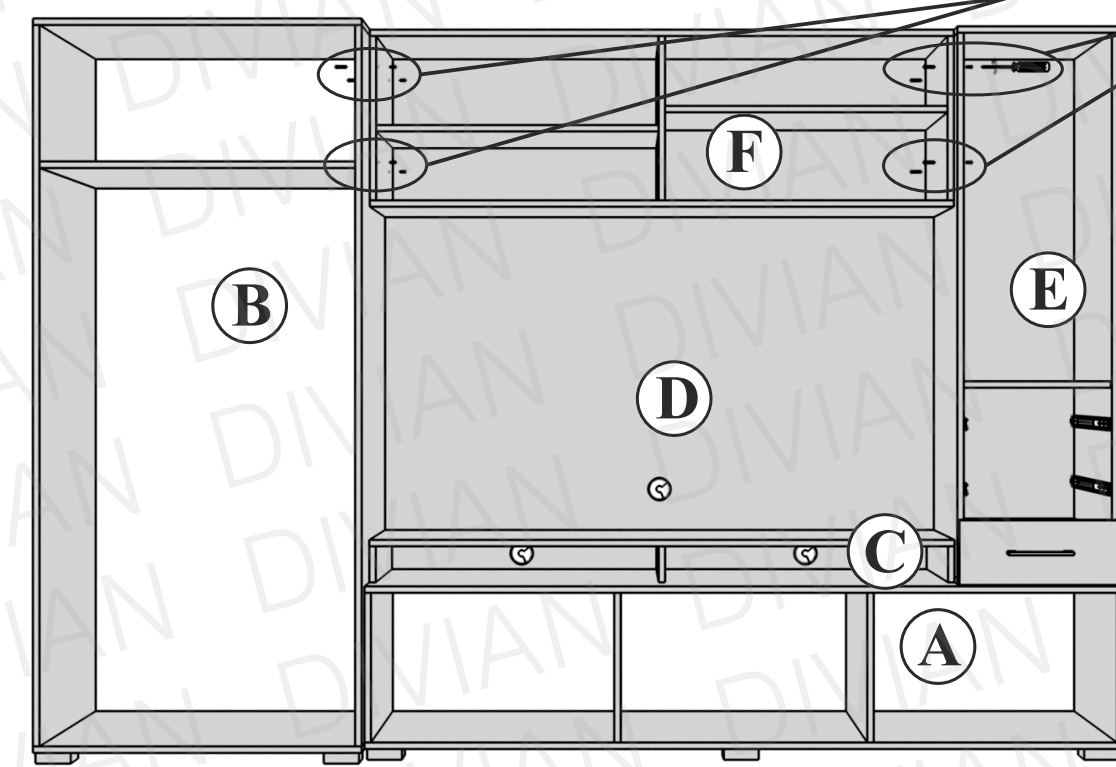
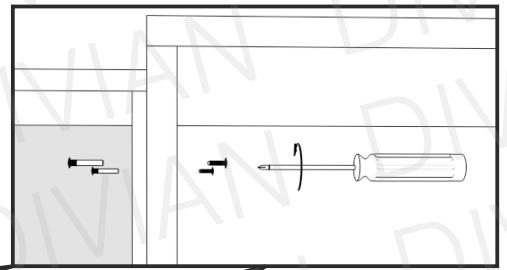
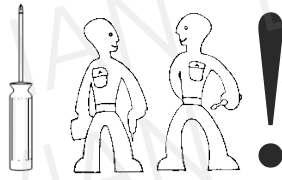

4

8x  M6x30 8x  M4x12



5

4x  M6x30 4x  M4x12

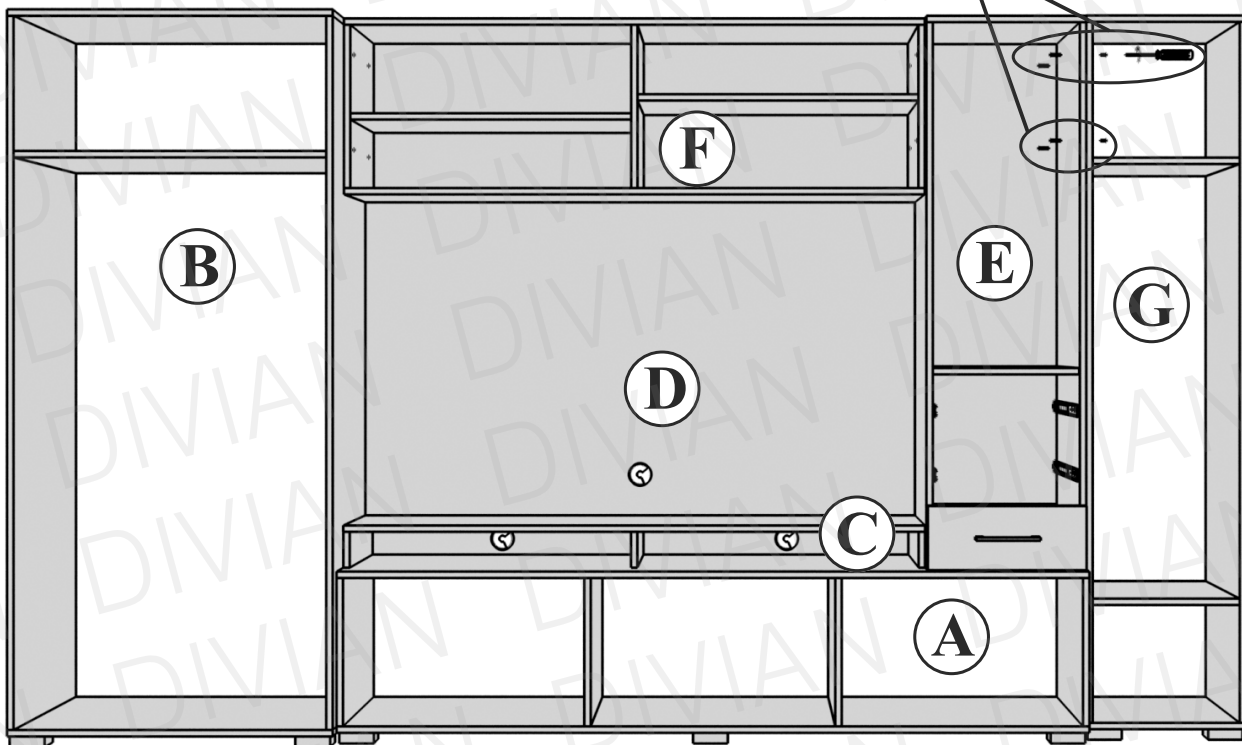
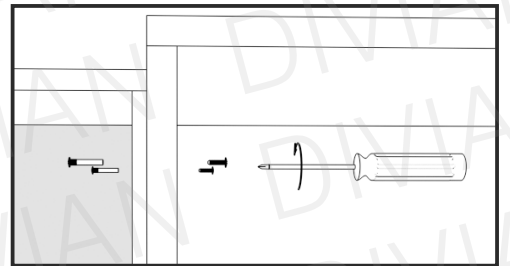
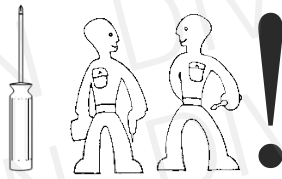

6

12x

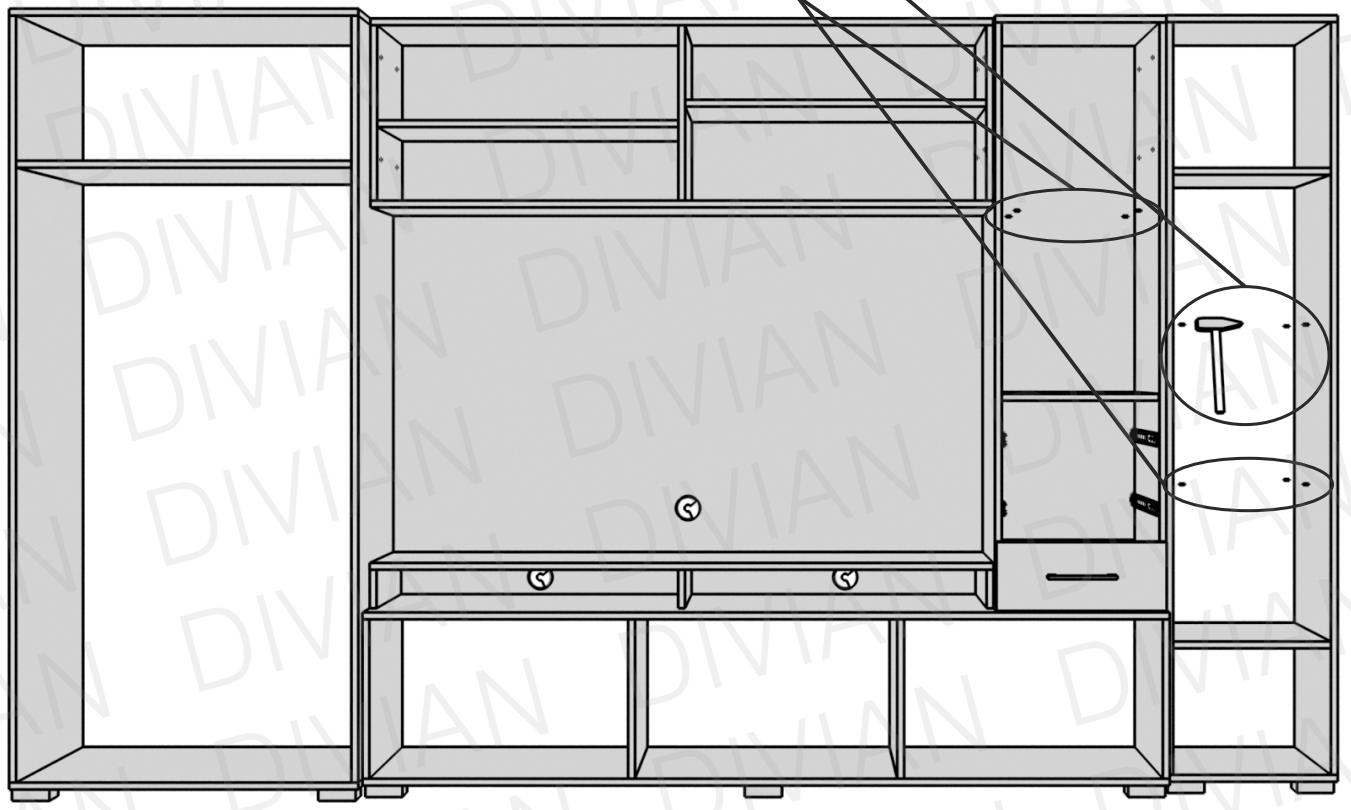
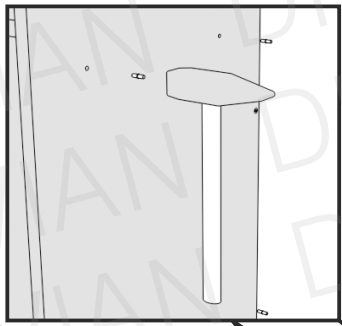
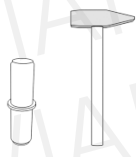

7

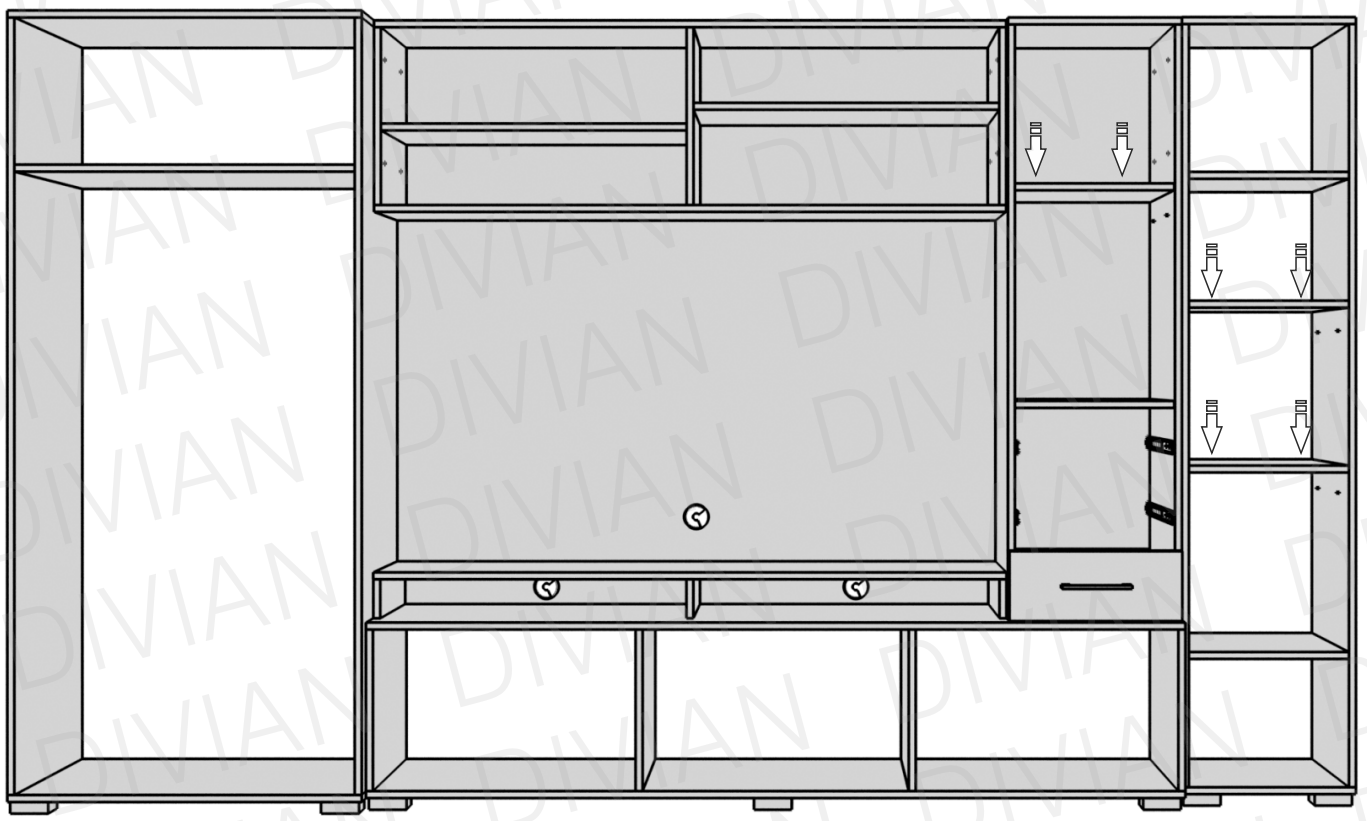

6

8

2x



4x

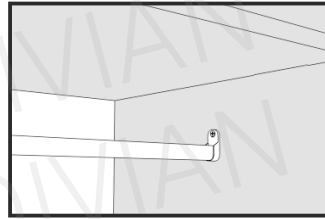
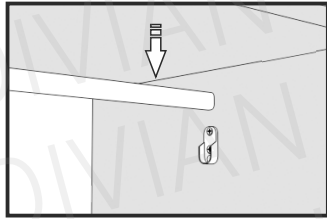
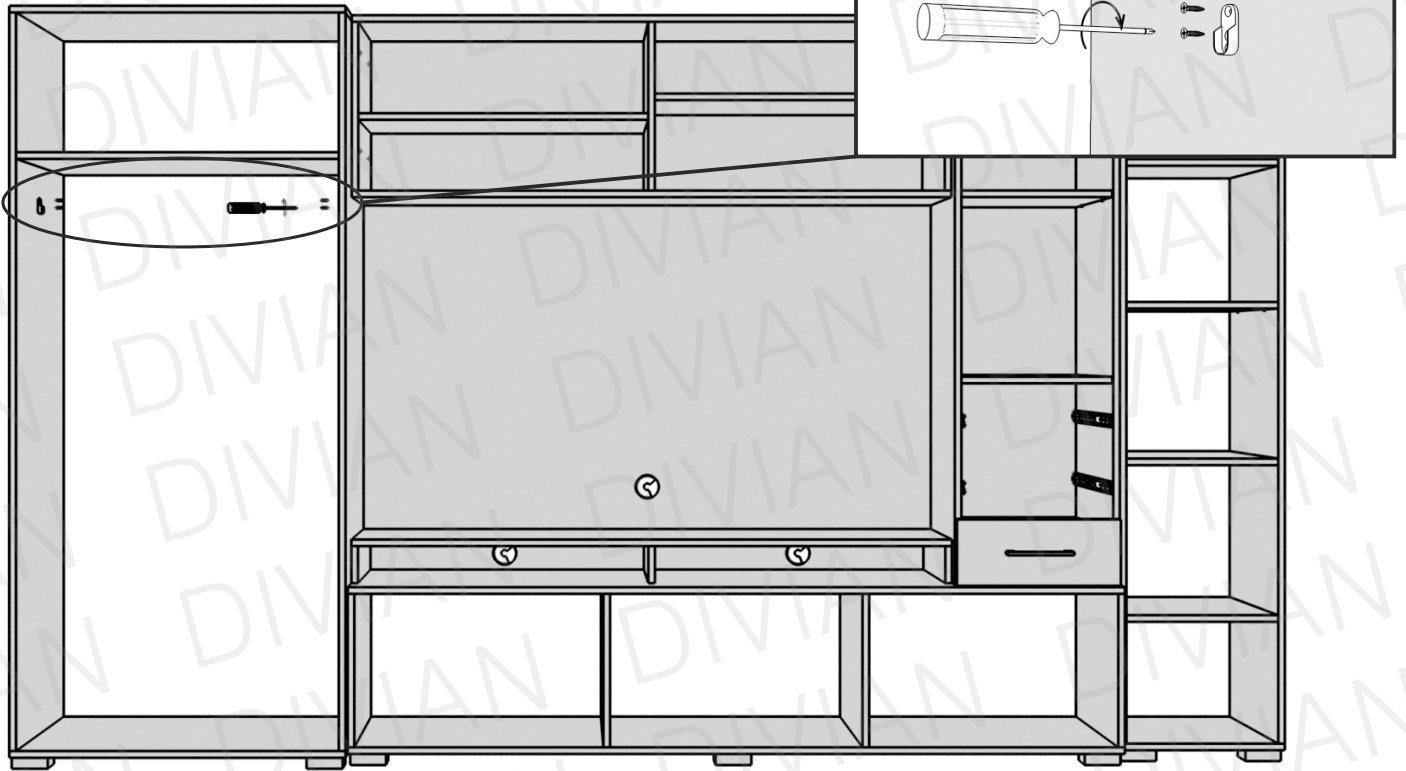

9

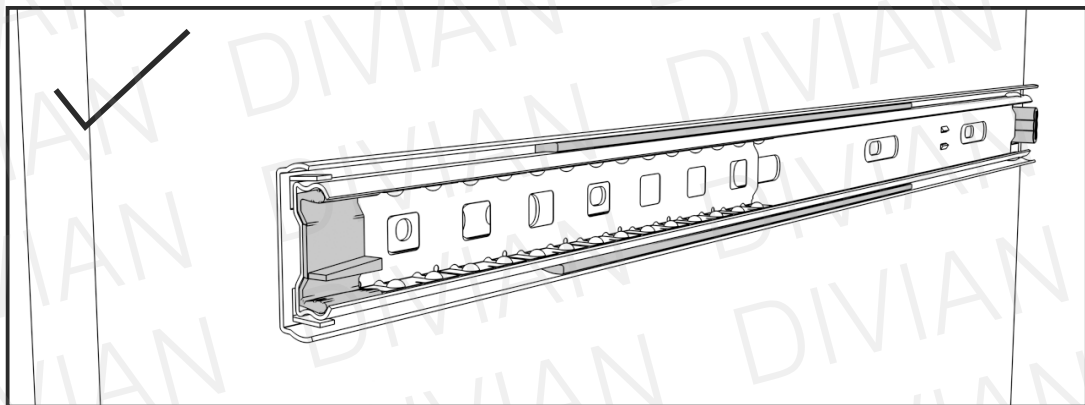
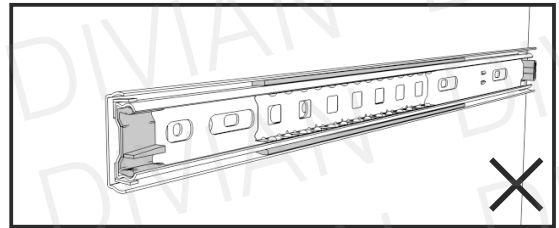
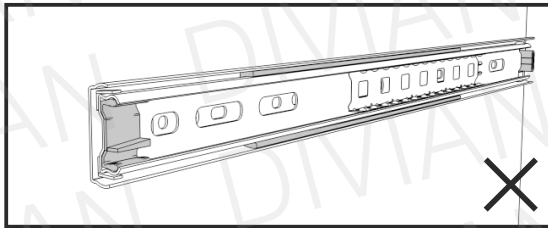

i

A fiók/fiókok behelyezése előtt, állítsa a megfelelő helyzetbe a síneket! A sínt állítsa zárt állapotba, a görgős elemrészt feltétlen húzza egészen előre!

10

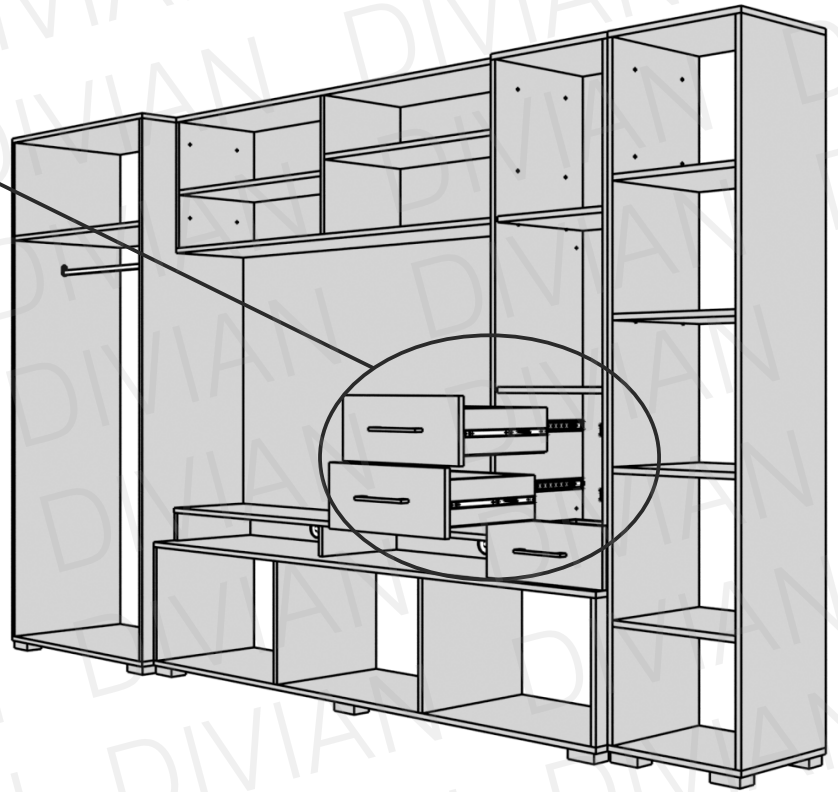
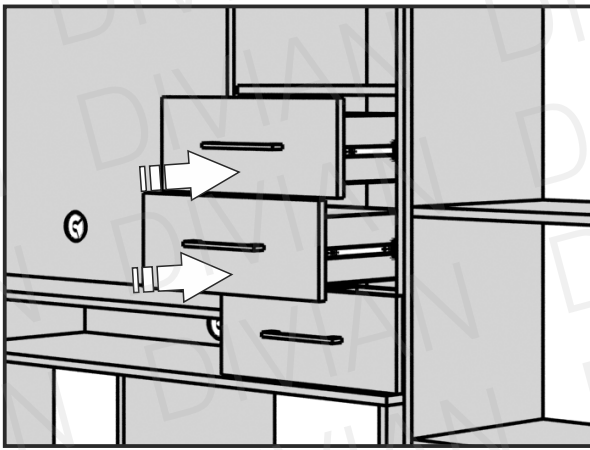

Pontos illesztés

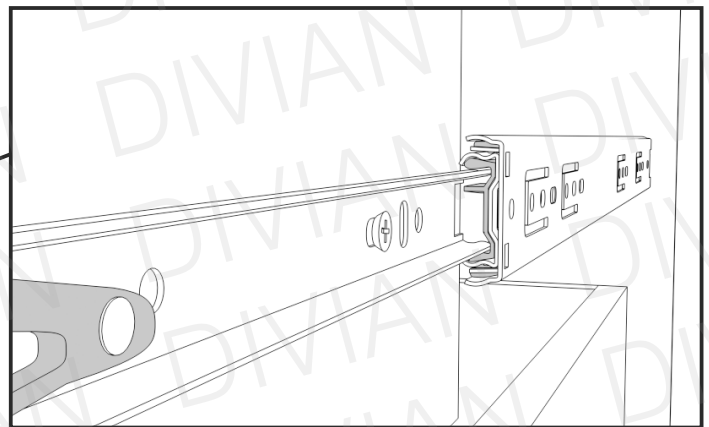
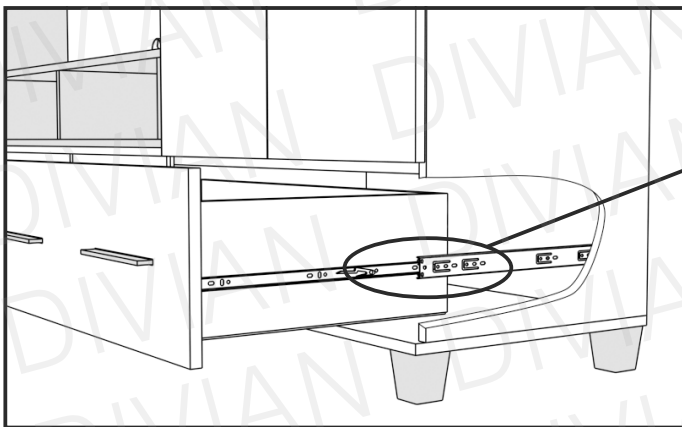

Illesszék a fióktestre szerelt sín párt a korpuszon található sínhez, mindkét oldalt ellenőrizték, hogy sikerült-e pontosan beilleszteni. Ezután tolják be a fiókot.

Ha nem sikerült elsőre, semmiképpen se rángassák a fiókot, húzzák vissza ki, és a 9. lépés szerint állítsák be a korpuszon található sín, majd ismételjék meg a 10. pontot.