

# ADELI

Art.-Nr.

279 479  
279 480

↔	1200
↕	1770
↗	520
	mm

1/8  
VO





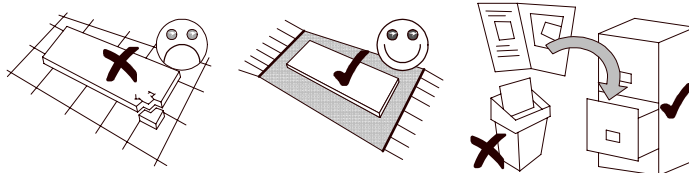
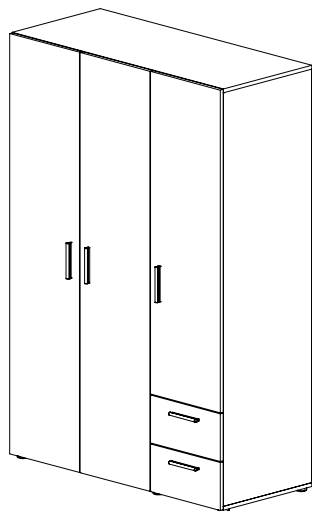
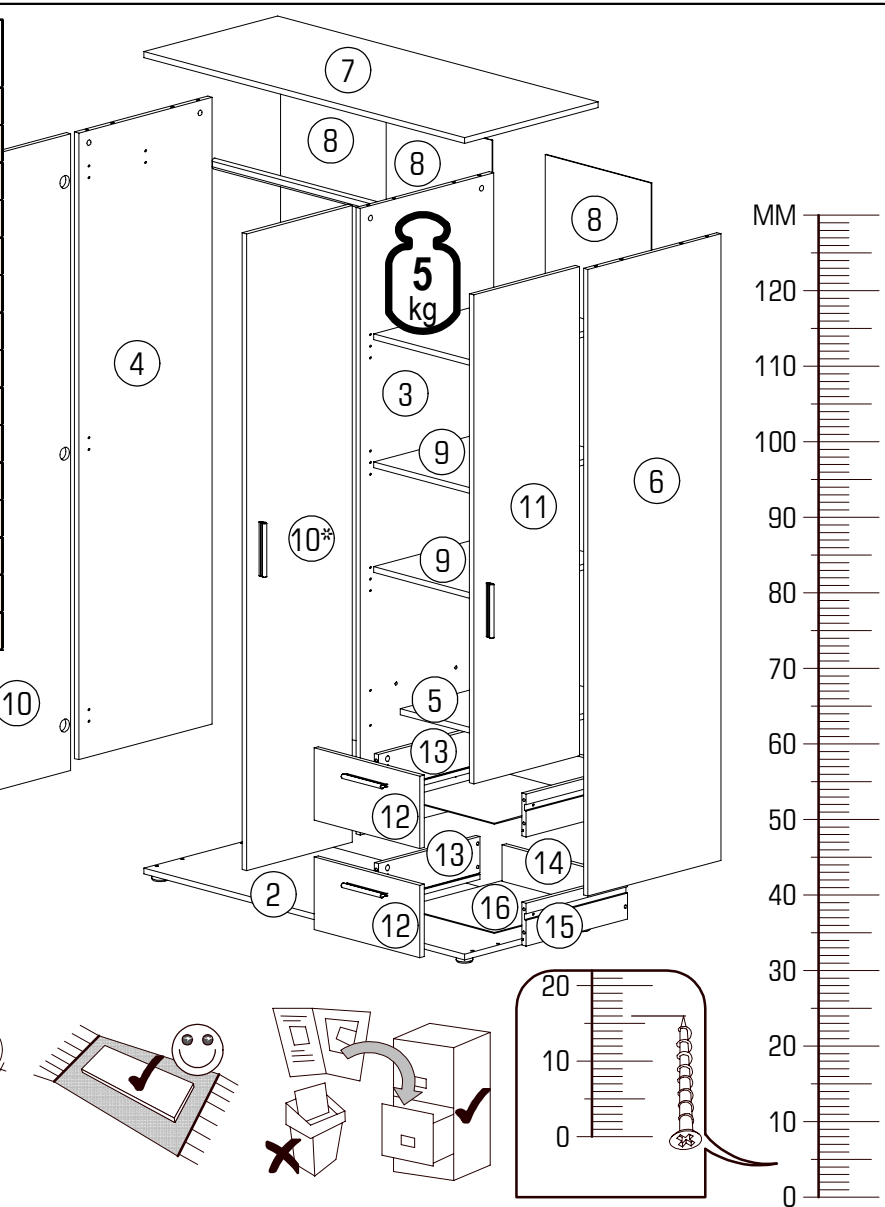



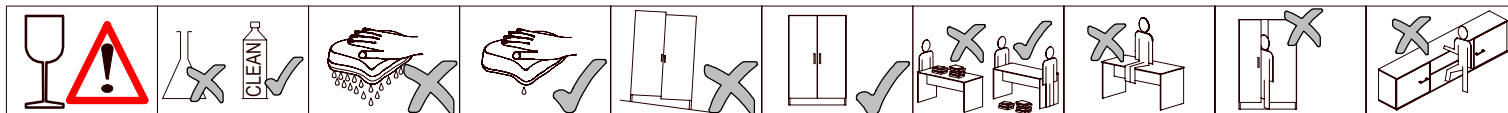

	120min			PZ1, PZ2	0,5 kg	3m	600 mm	Ø8	4

ID EE	ID			
17620	②	1200*500*16	1x	1/3
17621	③	1722*499*16	1x	2/3
17622	④	1722*499*16	1x	2/3
17623	⑤	375*498*16	1x	1/3
17624	⑥	1722*499*16	1x	2/3
17625	⑦	1200*500*16	1x	1/3
17626	⑧	1750*396*3	3x	3/3
17627	⑨	375*498*16	3x	1/3
17628	⑩	1750*396*16	2x	3/3
17629	⑪	1344*396*16	1x	3/3
17630	⑫	396*199*16	2x	3/3
17631	⑬	380*118*16	2x	1/3
13597	⑭	337*100*16	2x	1/3
17632	⑮	380*118*16	2x	1/3
17633	⑯	386*347*3	2x	1/3







22244.01	22705.00	22502.00	22300.00	33018.00	27000.00	21102.00	70013.01	70021.01	
Ø3,5x16	Ø6,8x8	M4x12	Ø7x50		Ø8x30	Ø1,6x20	Ø15x13		
A	B	C	D	E	F	G	H	I	J
8x	8x	4x	14x	2x	16x	75x	18x		18x
22430.00	30080.00	32030.00	24103.00	22243.00	24008.00	35101.01	70018.01		
Ø4x25	Ø44x15	L=148	Ø8	Ø3,5x15	3,0				
K	L	M	N	P	Q	R	S	T	T1
10x	6x	5x	14x	1x	24x	17x	12x		2x
70017.58	22213.00	31103.00	22236.00	36013.02	36013.02	36002.07	36002.07	22250.00	
L=767	Ø4x70		Ø2,5x16					Ø4x25	
T2	U	V	W	X1	X2	Y1	Y2	Z	
1x	1x	1x	17x	3x	3x	6x	6x	6x	

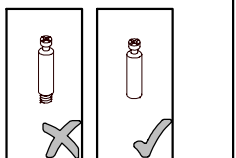
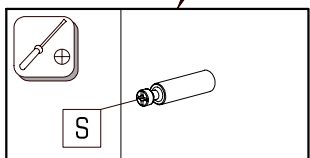
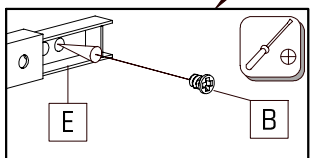
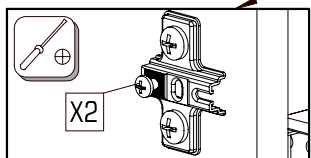
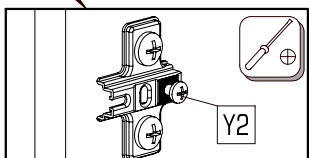
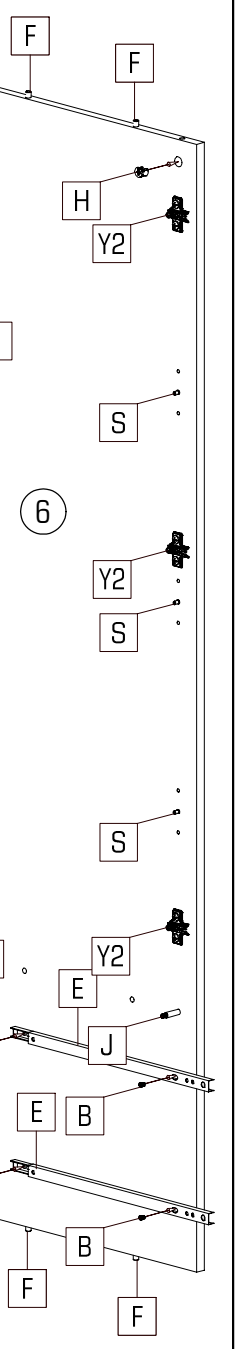
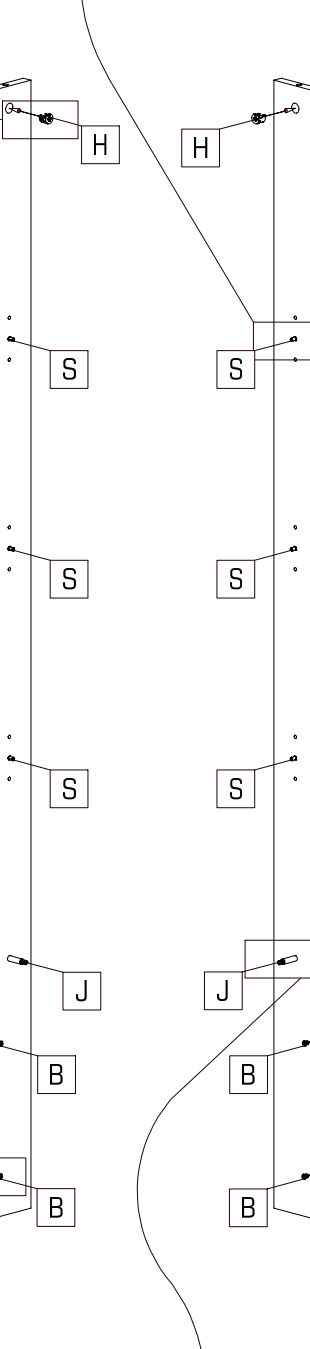
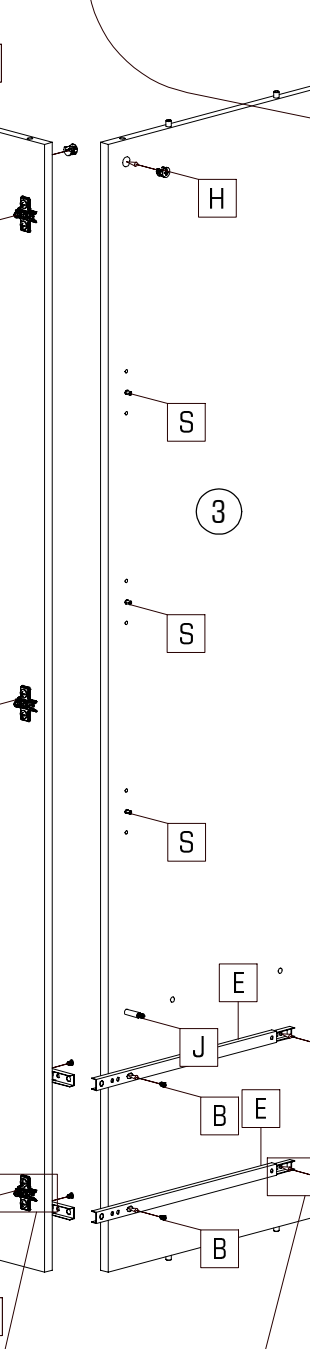
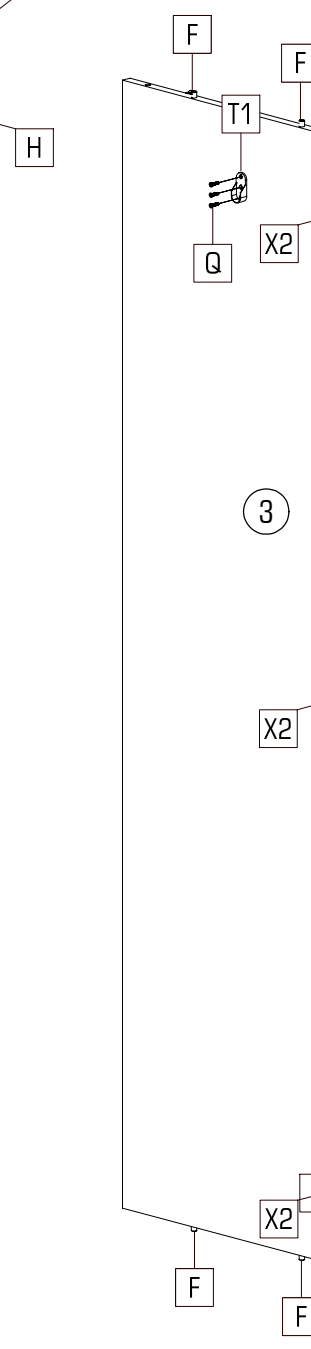
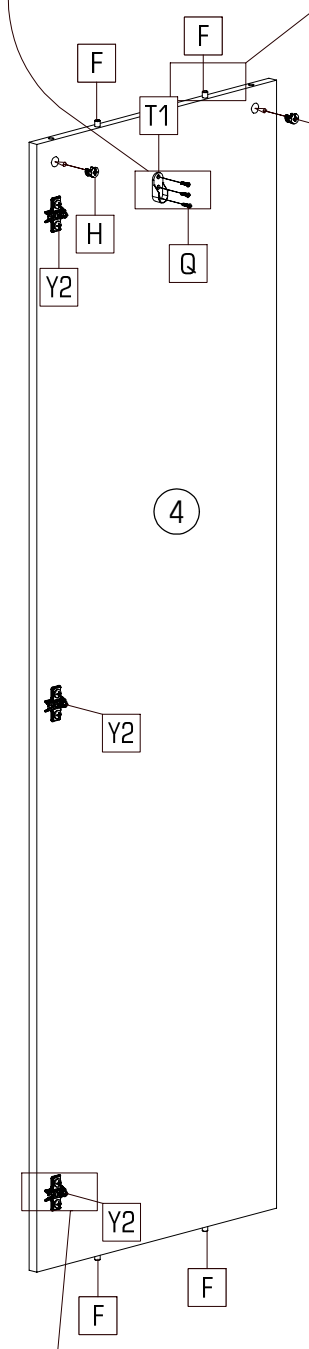
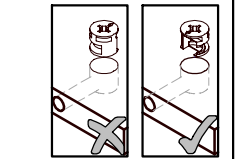
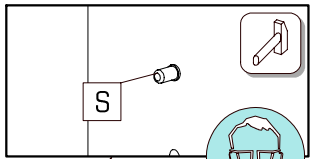
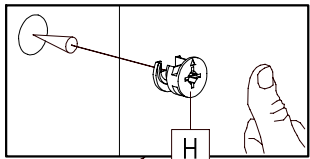
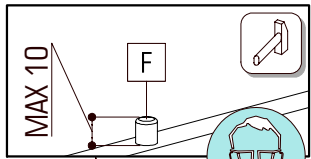
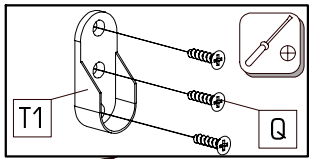

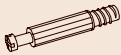

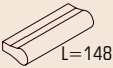
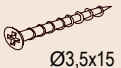
																			
B	8x	E	2x	F	12x	H	6x	J	4x	Q	6x	S	12x	T1	2x	X2	3x	Y2	6x

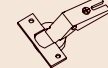

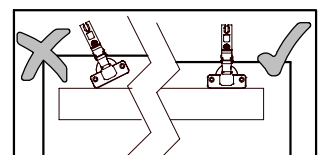
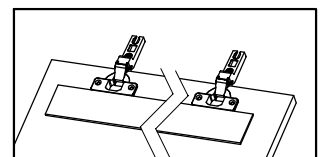
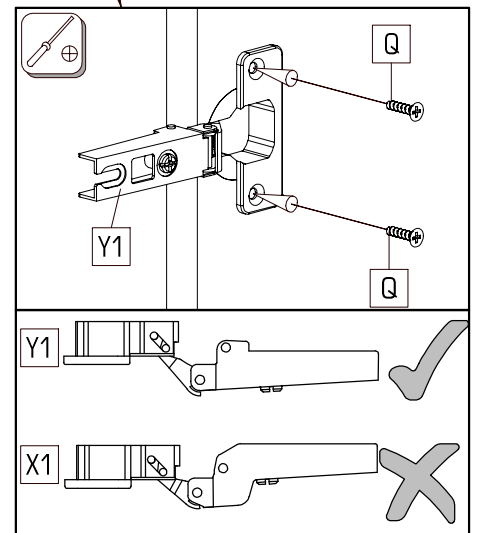
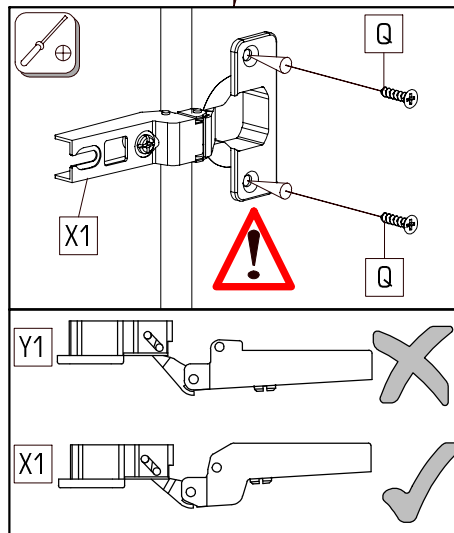
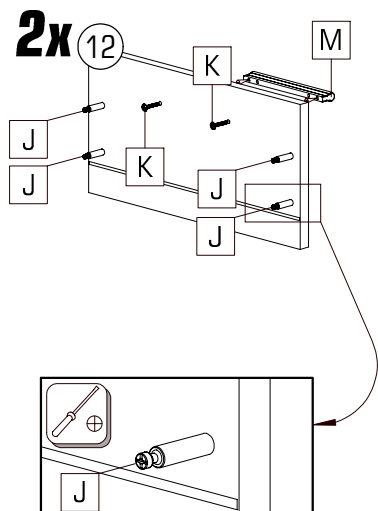
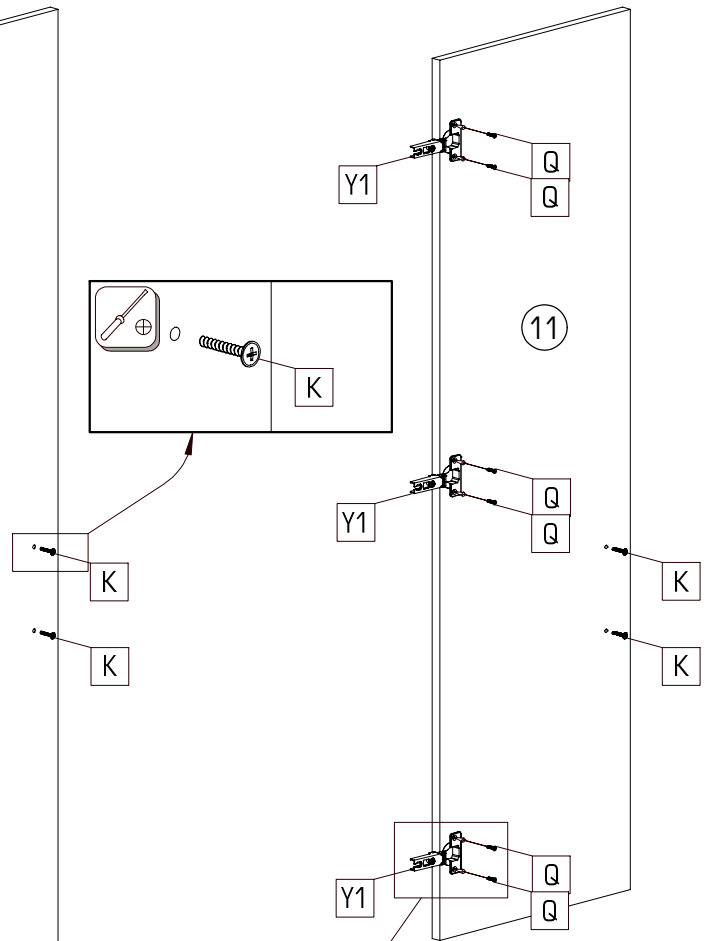
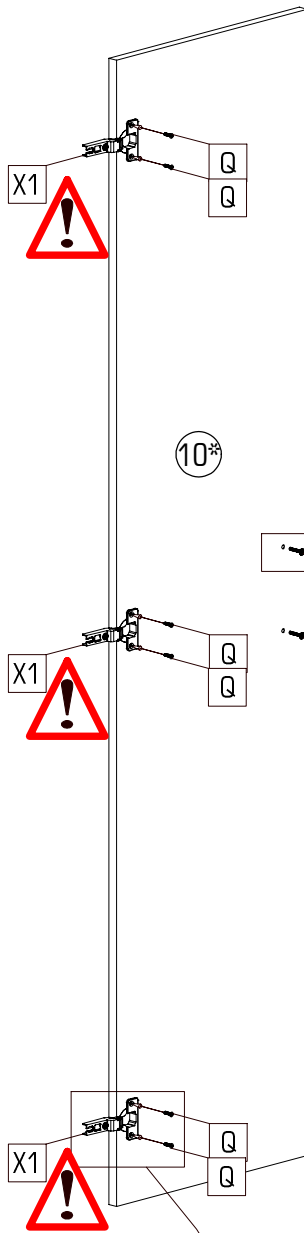
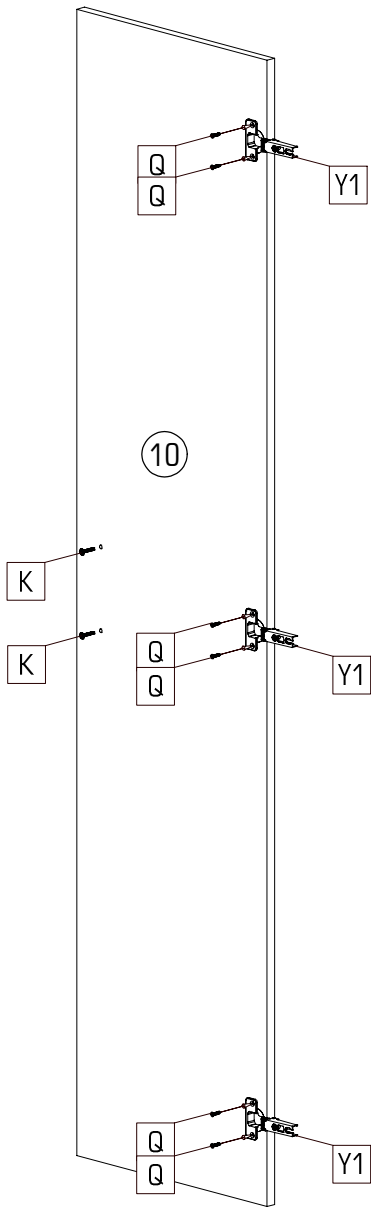

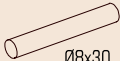

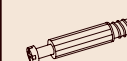
					
J 8x	K 10x Ø4x25	M 5x L=148	Q 18x Ø3.5x15	X1 3x	Y1 6x

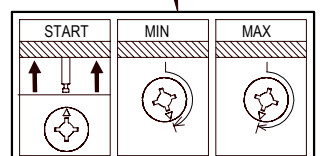
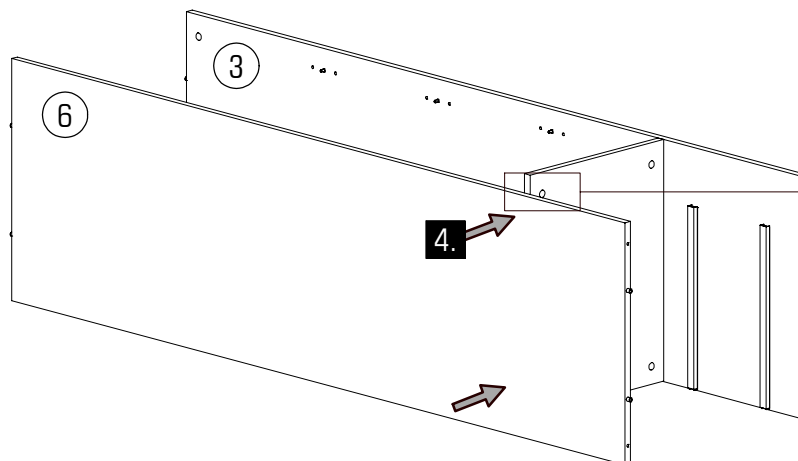
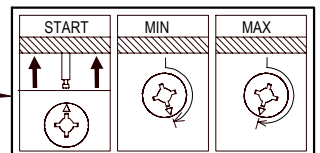
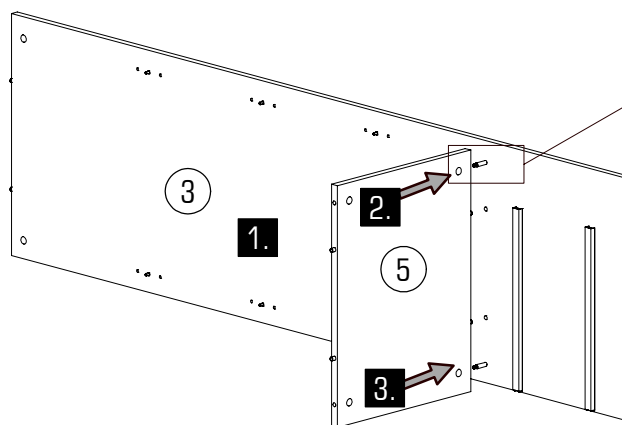
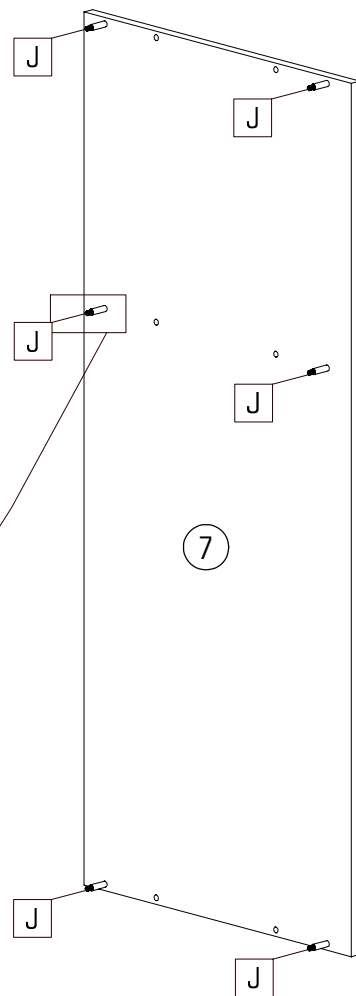
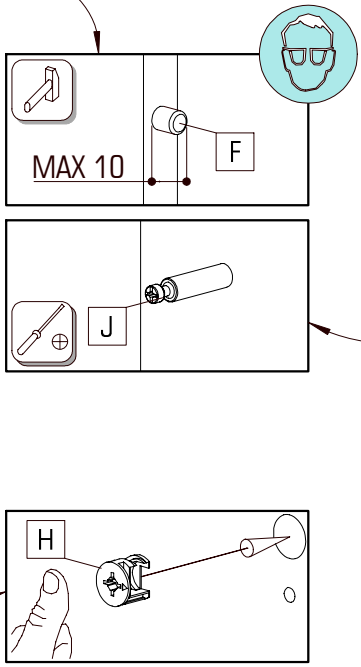
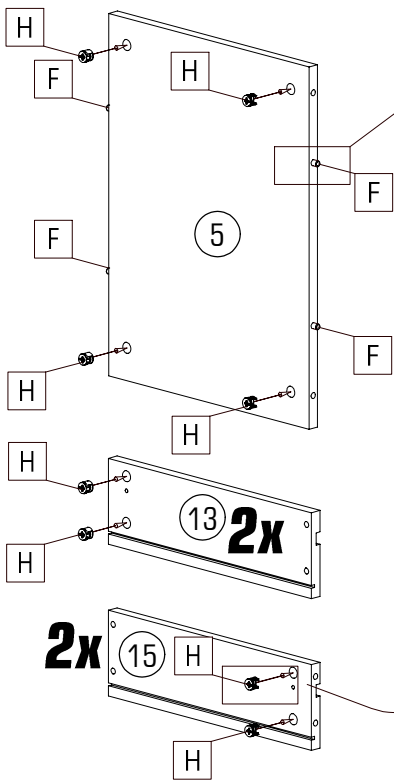
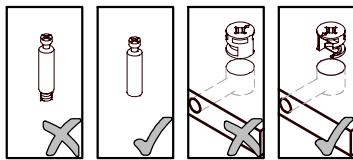

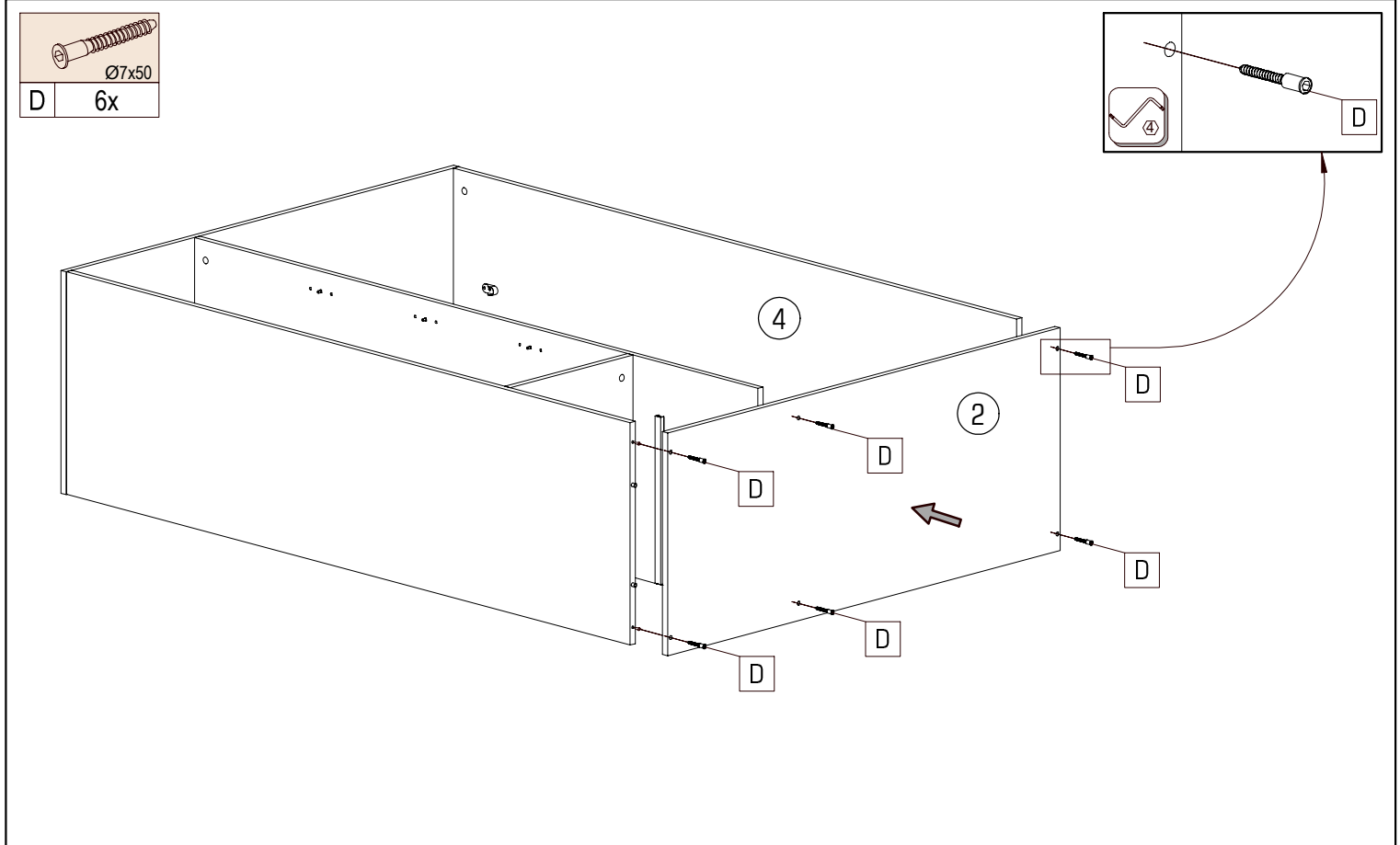
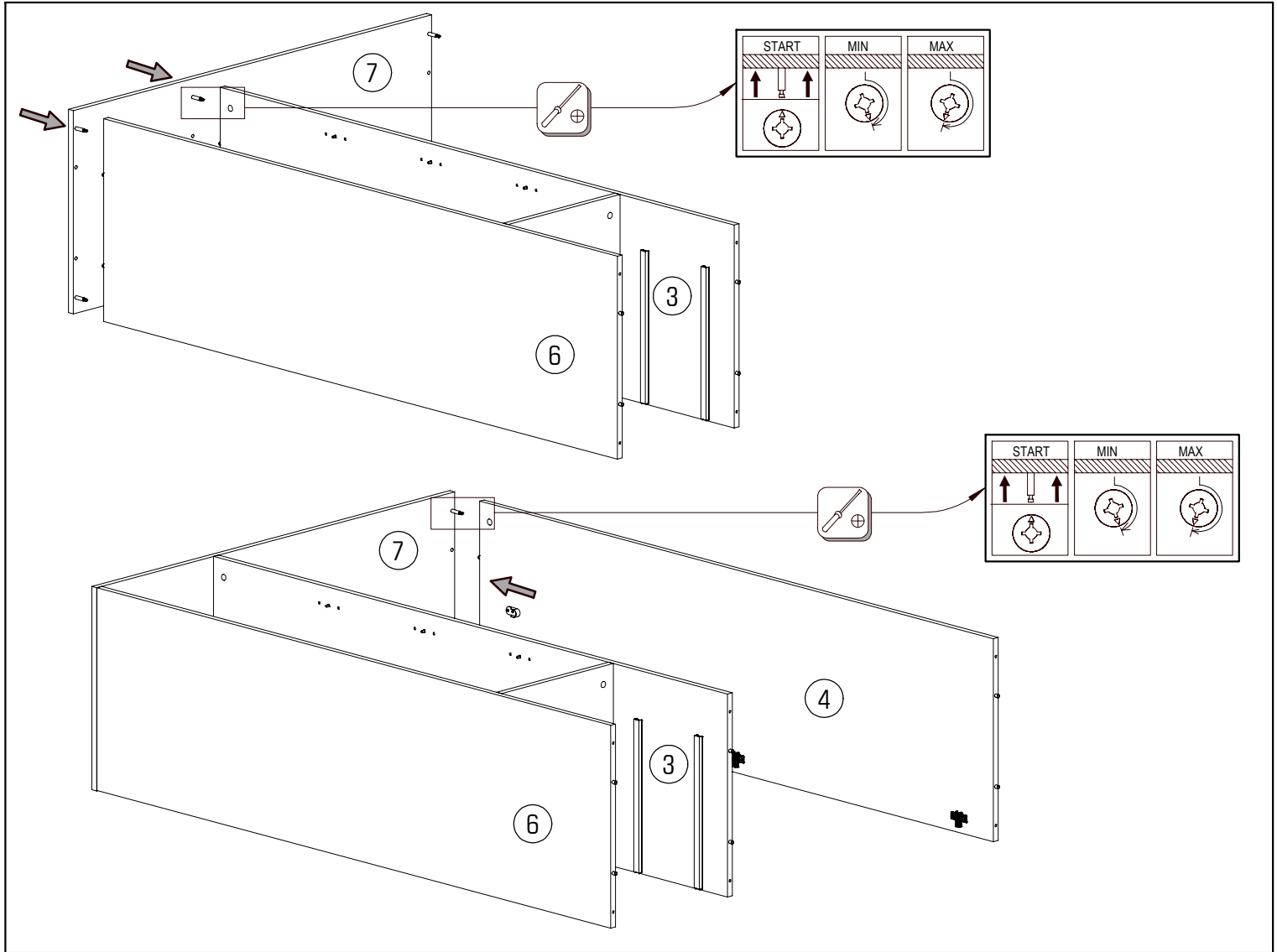

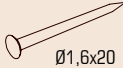
		
F 4x	H 12x	J 6x

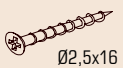

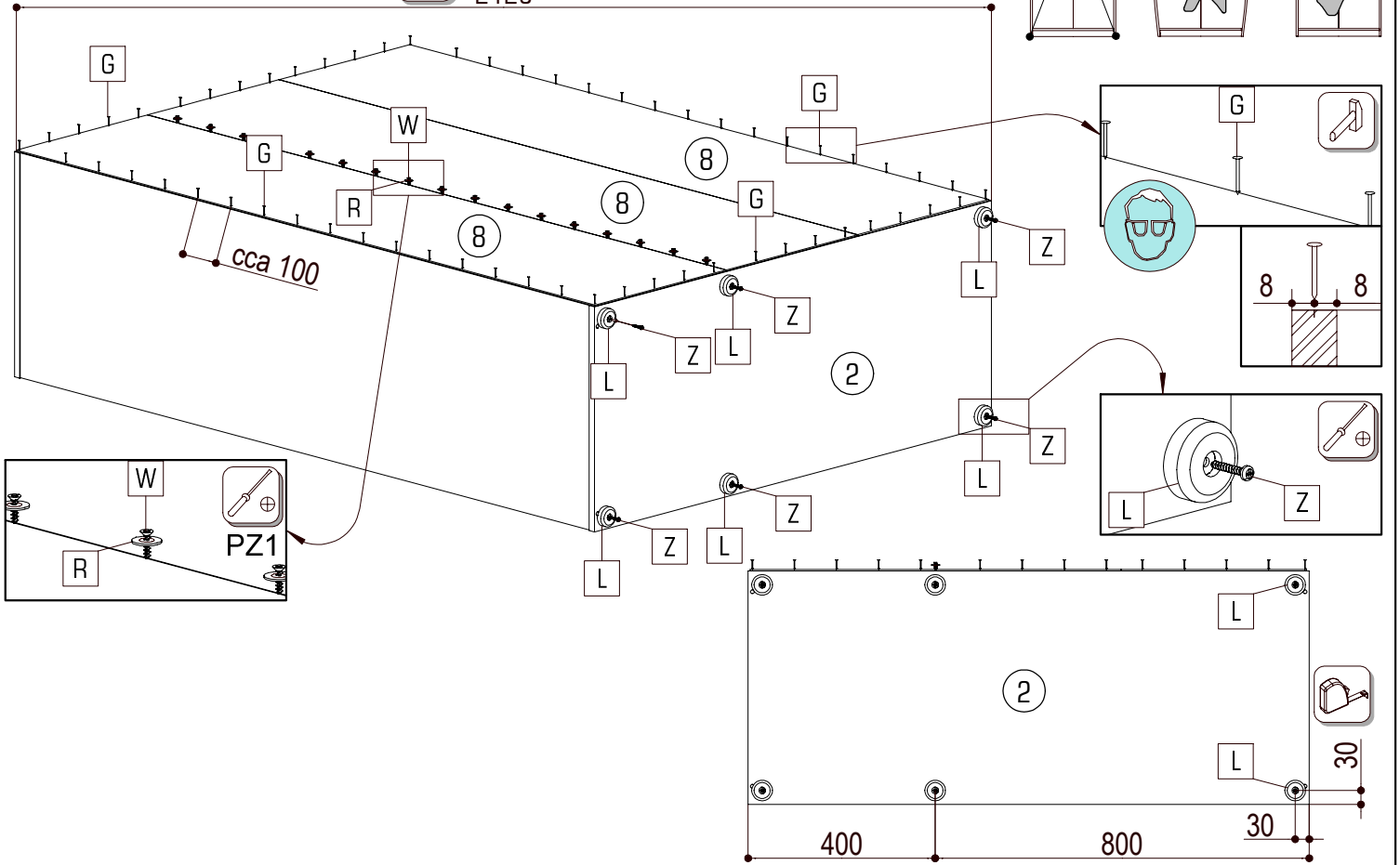

				
Ø1,6x20	Ø44x15	3,0	Ø2,5x16	Ø4x25
G 75x	L 6x	R 17x	W 17x	Z 6x

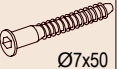

	
Ø3,5x16	Ø7x50
A 6x	D 8x

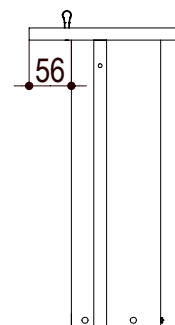
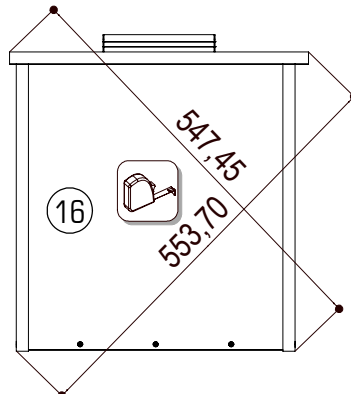
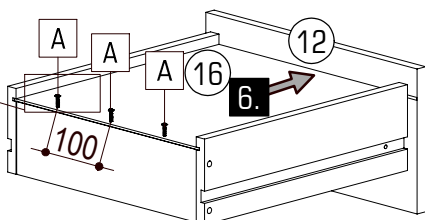
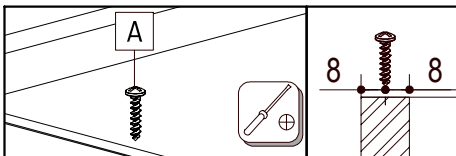
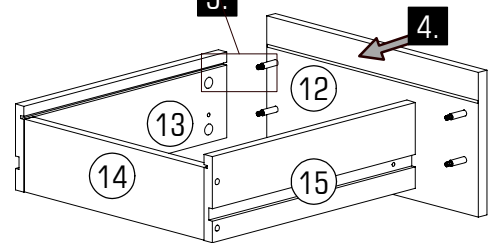
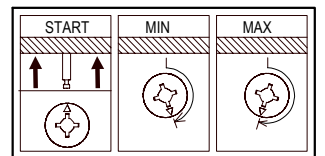
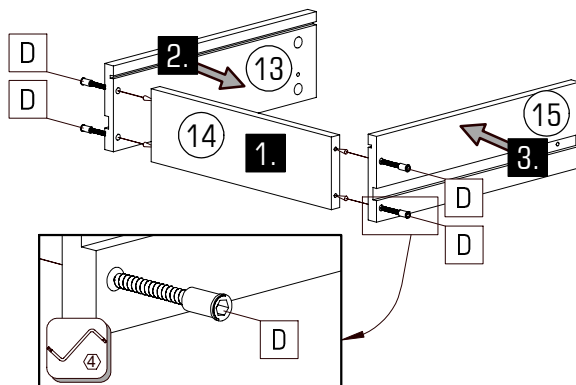
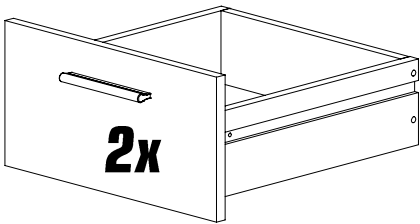

A 2x	N 6x	P 1x	T2 1x	U 1x	V 1x

	<b>1.</b>
	<b>2.</b>
	<b>3.</b>

--	--	--

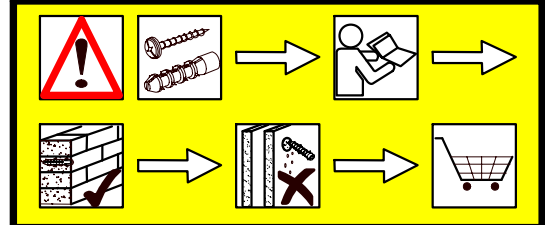

**Upozornenie!** Pevnosť steny sa musí pred montážou bezpodmienečne skontrolovať. Univerzálne hmoždenky, ktoré sú obsiahnuté v balení, používajte jedine pre pevné murivo ako je betón/tehla. Hmoždenky sa nesmú používať v prípade ľahkého stavebného muriva, dutina tehla, u sádrokartónových dosiek alebo iných konštrukcií rámu. U týchto murív je nutné použiť špeciálne hmoždenky! Tieto je možné dostať v špeciálnych predajniach so stavebným materiálom (stavebniny). Pri nedodržaní pokynov nepreberajú výrobcovia/predajci a dodávateľa zodpovednosť za vzniknuté škody.

**Upozornění!** Před montáží je nutné zkontrolovat stav stěny. Přiložené univerzální hmoždinky jsou určeny pouze k použití pro pevné zdivo jako beton/cihly. Hmoždinky do zdi se nesmí používat u dutinová cihla, zdiva jako pórovitý stavební kámen, sádrokartónová deska nebo jiný měkký materiál. U těchto zdív jsou nutné použít speciální hmoždinky! Jsou k dostání v speciálních prodejnách se stavebním materiálem. Při nedodržení těchto pokynů výrobce/prodejce a dovozce neručí za způsobené škody.

**Pažnja!** Prije montaže obvezno provjerite svojstvo zida. Priložene univerzalne tiple namijenjene su isključivo za masivne zidove od betona/opeke. Tiple za masivne zidove ne smiju se koristiti za zidove kao npr šupljina opeka laki sastavni elementi, gips-kartonске ploče ili drugi modularni načini gradnje. Za te zidove potrebne su eventualno specijalne tiple! Iste su dostupne u specijaliziranim trgovinama građevinskim materijalom. U slučaju nepridržavanja prethodno navedenih napomena, proizvođač/trgovac i uvoznik ne preuzimaju odgovornost!

**Achtung!** Die Wandbeschaffenheit ist vor der Montage unbedingt zu prüfen. Die beigelegten Universaldübel sind ausschließlich nur zur Verwendung für festes Mauerwerk wie Beton/Ziegel. Die Mauerdübel dürfen nicht bei Mauerwerk wie Hohlraumziegel, Leichtbausteinen, Gipskartonplatte oder anderer Rahmenbauweise verwendet werden. Bei diesen Mauerwerken sind gegebenenfalls Spezialdübel zu verwenden! Diese sind in einem Fachgeschäft (Baumarkt) erhältlich. Bei Nichteinhaltung wird seitens Produzenten/Händler und Importeur keine Haftung übernommen.

**Vigyázat!** Szerelés előtt a falfelületet feltétlenül vizsgálja meg. A mellékelt univerzális tiplé kizárólag stabil falazathoz használható mint például beton/tégla. A fali tiplé nem használható könnyű építőkövek hez, üreg tégla, gipszkarton lapokhoz vagy más fávázás építményekhez. Ezekhez a falfelületekhez csak speciális tiplik használhatóak, melyek szaküzletekben (barkácsáruházakban) beszerezhetőek. Fentiek figyelmen kívül hagyása esetén a gyártó/kereskedő vagy forgalmazó nem vállal felelősséget.

**Uwaga!** Ścianę należy sprawdzić przed montażem. Dołączone uniwersalne kolki rozporowe są odpowiednie tylko do stosowania w mocnych murach, takich jak beton lub cegła. Nie rób z pomocą kółków rozporowych murowanych, takich jak pustak, lekka kostka, powierzchnie takie jak płyty gipsowo-kartonowe lub inne systemy ram. Jeśli dotyczy, muszą to być określone kolki rozporowe być użyty! Są one dostępne w specjalistycznym sklepie (sklepie ze sprzętem) niezgodność, producent / sprzedawca lub importer nie ponoszą odpowiedzialności.

**Prudentă!** Zidul trebuie examinat înainte de asamblare prizele de perete sunt adecvatenumai pentru utilizarea în zidărie fermă, cum ar fi betonul bloc sau cărămidă. Nu folosiți zidăria zidurilor de perete, cum ar fi cărămida goală, blocul ușor, suprafețe cum ar fi gips-carton sau altă încadrare sisteme. Dacă este cazul, trebuie folosite anumite prize de perete! Acestea sunt disponibile la un magazin specializat (magazin de hardware). În caz de nerespectare, producătorul / vânzătorul cu amănuntul sau importatorul nu își asumă răspunderea.

**Увага!** Стан стіни необхідно перевірити перед установкою. Укладені універсальні дюбелі призначені лише для використання з фіксованими Кладка, як бетон / цегла. Анкери для стін не повинні використовуватися для кладки Порожни цегли, легкі будівельні блоки, гіпсокартон або інша каркасна конструкція бути використаним! З цією кладкою можуть застосовуватися спеціальні дюбелі використання! Вони доступні в спеціалізованому магазині (магазині апаратних засобів) Виробник / дилер та імпортер не несе відповідальності.

C 4x	N 8x

